



JAPAN P&I CLUB

Vol.39 April 2017

P&I Loss Prevention Bulletin

The Japan Ship Owners' Mutual Protection & Indemnity Association Loss Prevention and Ship Inspection Department

Electronic Chart Display and Information System

ECDIS



INDEX

Codes Table	4
Introduction	6
Chapter 1 Electronic Chart Display and Information System (ECDIS)	
1-1 ECDIS Functions	8
1-2 ECDIS Overview	11
Chapter 2 Overview of Rules Regarding Electronic Charts	
2-1 Nautical Charts for Navigation	12
2-2 The International Convention for the Safety of Life at Sea (SOLAS) Chapter V	12
2-3 Fitting Requirements	14
Chapter 3 Electronic Charts	
3-1 Differences between the Electronic Chart System (ECS) and Electronic Chart Display and Information System (ECDIS)	15
3-2 Vector Charts	15
3-3 Raster Navigational Charts	17
3-4 Differences between the Raster Chart Display System (RCDS) and Electronic Chart Display and Information System (ECDIS)	18
3-5 Classification of Official Charts and Unofficial Charts	20
3-6 Backups	20
3-7 Approval by Port State Control (PSC)	21

Chapter 4 ECDIS Familiarisation Training

4-1 STCW	22
4-2 Familiarisation Training	23

Chapter 5 Handling of Electronic Charts from the Viewpoint of the Master and Officers

5-1 Human Error due to Overdependence	26
5-2 Objectives of ECDIS	29
5-3 BTM (Bridge Team Management) and ECDIS	30
5-4 ECDIS Information Management	35

Conclusion	35
-------------------------	----

Attachments and Reference Material

Attachment ①	
ANNEX24 Resolution MSC.232(82) 「Performance standards for Electric Chart Display and Information System(ECDIS)	37
Attachment ②	
Ref. T2-OSSHE/2.7.1 SN.1/Circ.255 (24 July 2006) 「ADDITIONAL GUIDANCE ON CHART DATUMS AND THE ACCURACY OF POSITIONS ON CHARTSMO 」	44
Attachment ③	
Ref. T2-OSS/2.7 SN.1/Circ.207/Rev.1(22 October 2007) 「DIFFERENCES BETWEEN RCDS AND ECDIS」	46
Attachment ④	
Ref. T2-OSS/2.7.1 SN.1/Circ.276(10 December 2008) 「TRANSITIONING FROM PAPER CHART TO ELECTRONIC CHART DISPLAY AND INFORMATION SYSTEMS (ECDIS) NAVIGATION」	48
Attachment ⑤	
STCW Convention Table A-II/2 Extract	51

CODES TABLE

Abbreviation of Treaty/Agreement etc.	
COLREGS	International Regulations for Preventing Collisions at Sea, 1972
ISM Code	International Management Code for the Safe Operation of Ships and for Pollution Prevention (International Safety Management Code)
S-66	Facts about Electronic Charts and Carriage Requirements
SOLAS	International Convention for the Safety of Life at Sea, 1974
STCW	International Convention on Standards of Training, Certification and Watchkeeping for Seafarers, 1978

Abbreviation of Organization etc.	
IHO	International Hydrographic Organization
IMO	International Maritime Organization
MOU	Memorandum Of Understanding on Port State Control
NHO	National Hydrographic Office
PSC	Port State Control
UKHO	United Kingdom Hydrographic Office

Abbreviation of Equipment and others	
AIS	Automatic Identification System
ARPA	Automatic Radar Plotting Aids
BTM	Bridge Team Management
CRM	Cockpit Resource Management
ECDIS	Electronic Chart Display and Information System
ECS	Electronic Chart System
ENC	Electronic Navigational Chart Digital Data Base of All information (Point, Line and Area) on the display
GNSS	Global Navigation Satellite System Generic Name of Satellite System(GPS, GLONASS, Galileo and etc.)
GPS	Global Positioning System
Japan ENC	Japan Electronic Navigational Chart
RCDS	Raster Chart Display System
RENC	Regional ENC Co-ordination Center
RNC	Raster Navigational Chart
SA Certificate	Scheme Administrator Certificate : SA Certificate
SENC	System Electronic Navigational Chart
WGS-84	World Geodetic System-84



Introduction

The Hydrographic Department of the Japan Coast Guard (now known as the Hydrographic and Oceanographic Department, Japan Coast Guard) published the world's first ever electronic chart (Tokyo Bay to Ashizuri Misaki(Cape Ashizuri)) in March 1995. Since then, with developments in computer technology, equipment with advanced functions known as the Electronic Chart Display and Information System (“ECDIS”) has been developed and this is where we stand today.

Before the introduction of ECDIS, a paper nautical chart was used to create a navigation plan. A Gyro compass, radar and radio navigation equipment were used calculate the ship's position, and this information was transcribed on the paper chart. Also, with the appearance of the GNSS (Global Navigation Satellite System, GNSS being the generic term for the satellite positioning system known as GPS (USA), GLONASS (Russia), and Galileo (EU)), we were able to obtain highly accurate position information according to Latitude and Longitude, but the position of the vessel continued to be checked using a paper nautical chart.

It used to be that the navigation plan was prepared and the vessel position checked in order to create the nautical chart table. Nowadays, when ECDIS is compulsory, the vessel is manoeuvred from the conning position while reading the displayed nautical chart and vessel position information. Further, although there are no plans to scrap the paper chart, navigation without the use of the paper chart is becoming a reality. From the viewpoint of the Conning Officer (Master/Officer), this is considered to be a major revolution in the use of nautical charts. However, basic manoeuvring has not changed with the appearance of ECDIS, and this is carried out using a system made up of the 3 elements shown in Table 1.

In the words of Kinzo Inoue, the basic principle of manoeuvring or vessel handling is the knowledge that “a vessel floats in water and returns to its original position after a list. It is manoeuvred with the assistance of the rudder, main engine(s) and other auxiliary equipment, using knowledge of the rolling, pitching and yawing characteristics of the vessel in waves. In handling the vessel it is necessary to consider the effects of environmental conditions while controlling the position of the vessel, its attitude, and its speed, to move the vessel in the designed direction in a safe and efficient manner, and to stop at the intended position (Theory and Practice of Ship Handling, Kinzo Inoue, Honorary Professor, Kobe University).”, and a summary of this is shown in Figure 2.



Sponsored by FURUNO
Electronic Chart Display and
Information System (ECDIS)
FMD-3300



Sponsored by FURUNO
GNSS
GP-170

Table : 1 Constituent Elements of the Maneuvering System

Ship navigation system	Ship navigation environment	Geomorphic environment	The environment consisting of the terrain, structures, and water depth which are characteristic to that location
		Natural environment	The environmental changes which occur over time and are caused by nature. Factors such as weather, sea conditions, seasons, day and night
		Traffic environment	This is an artificially created environment, and consists of artificial elements such as other vessels, sailing route, navigational aids and traffic rules.
	Vessel	Hull	Size and draft of the vessel
		Motion controllers	Equipment used to move the vessel (such as main engine, steering gear, and nautical instruments)
		Motion performance	Factors such as course, speed, turning circle
	Operator	Operating technology	Person who has the skills to operate the vessel, and uses it to control the vessel
		Operating system	Factors such as navigational watch, bridge manning plan

From this viewpoint, ECDIS is just one part of the system to provide information, and excessive trust in the information generated by ECDIS could result in a drop in the operating skills of the Conning Officer, or cause the Conning Officer to overlook vital information. If unmanned vessels make an appearance in the future, different rules may apply, but in the present situation in which the vessel is operated by Ship's crew who are on board, we need to go back to basics and consider the ECDIS configuration and how to handle it for the task of manoeuvring.

Figure : 2 Ship Maneuvering

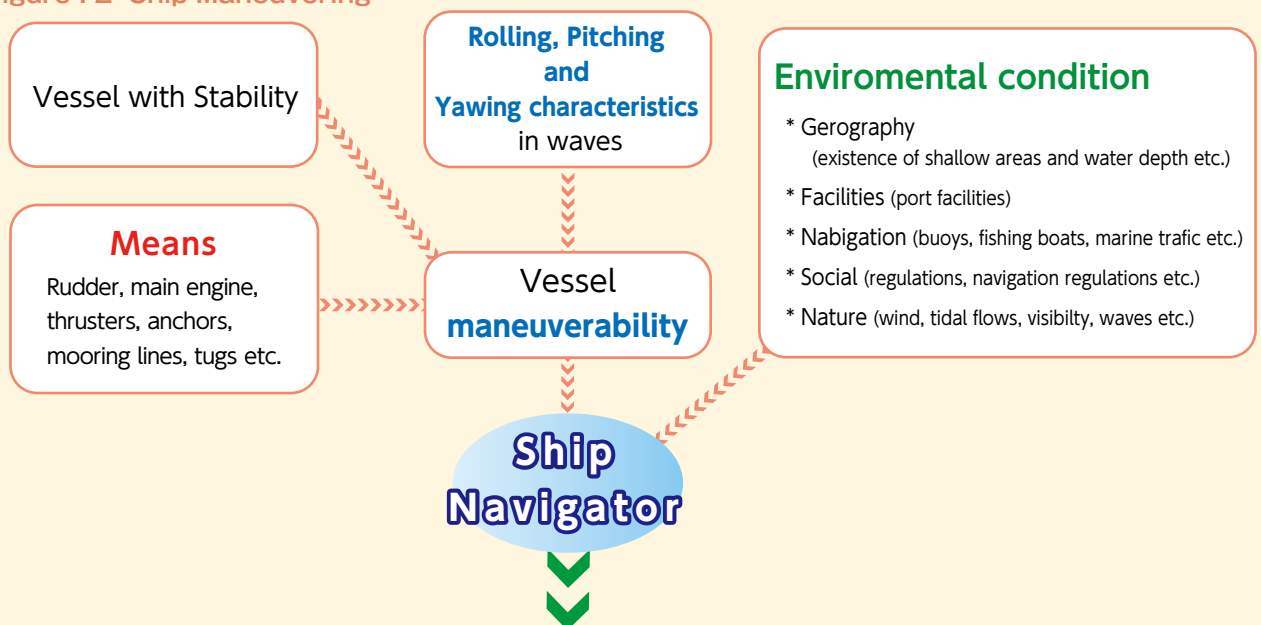

Control of vessel position, attitude, and speed for safe and efficient

- * **movement in the required direction**
- * **stopping at the required position**

Chapter 1

Electronic Chart Display and Information System (ECDIS)

1 – 1 ECDIS Functions

The definition in Performance Standards for ECDIS (Resolution MSC.232(82), adopted on 5 December 2006 (hereinafter referred to as MSC.232(82): See Attachment ①), 3. Definition 3.1, “Electronic Chart Display and Information System (ECDIS)) means that a navigation information system with adequate back-up arrangements can be accepted as an up-to-date chart as required by regulations V/19 and V/27 of the 1974 SOLAS Convention, as amended. ECDIS complies by displaying selected information “from a System Electronic Navigational Chart (SENC) with positional information from navigation sensors to assist the mariner in route planning and route monitoring, and if required display additional navigation-related information.” .

In other words, ECDIS is an information system for navigation that is not only an alternative to a paper chart, but has various functions such as checking the position of the vessel using GNSS, reusable navigation planning (Route Planning), and showing the bearings and distance to the course deviation point or course alternating point from the set route (Route Monitoring). It can also warn the Master or crew that the vessel is crossing the set safety isobaths, or approaching a hazardous object (see Ref. 3,4 and 5).

Ref. 3 Sample of Preventative Alarm for Grounding (Crossing Safety Contour Line)

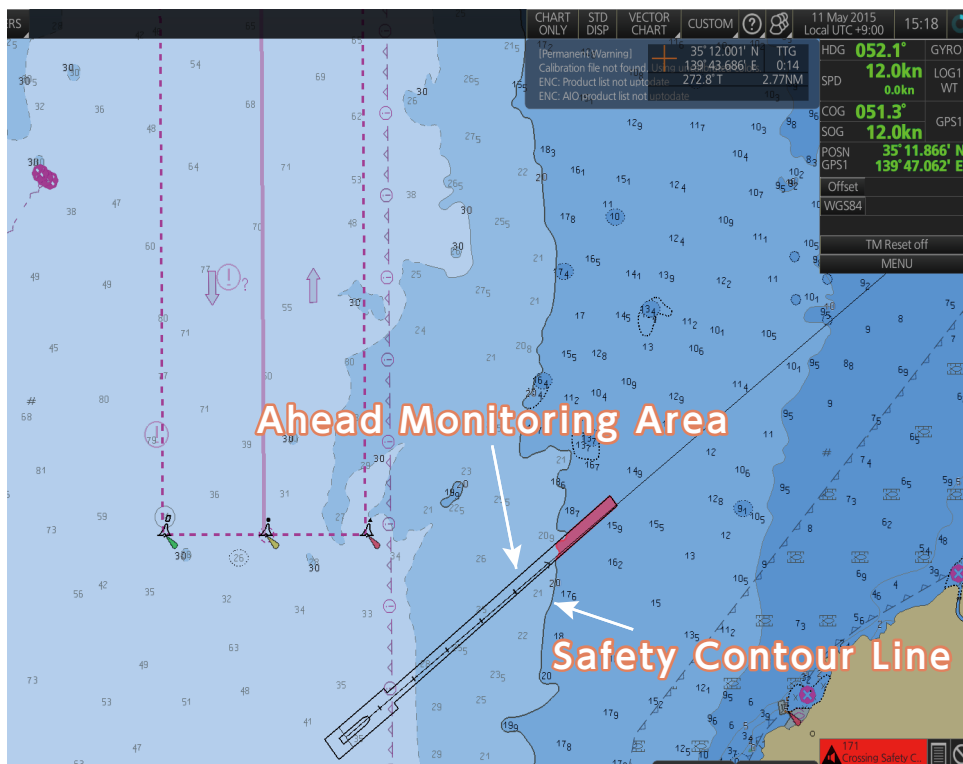

Sponsored by Japan Marine Science Inc.

Ref. 4 Sample Display of Safety Check under Voyage Planning
 (Red Color route : Voyage Planning Route pass through Warning area (special condition area))

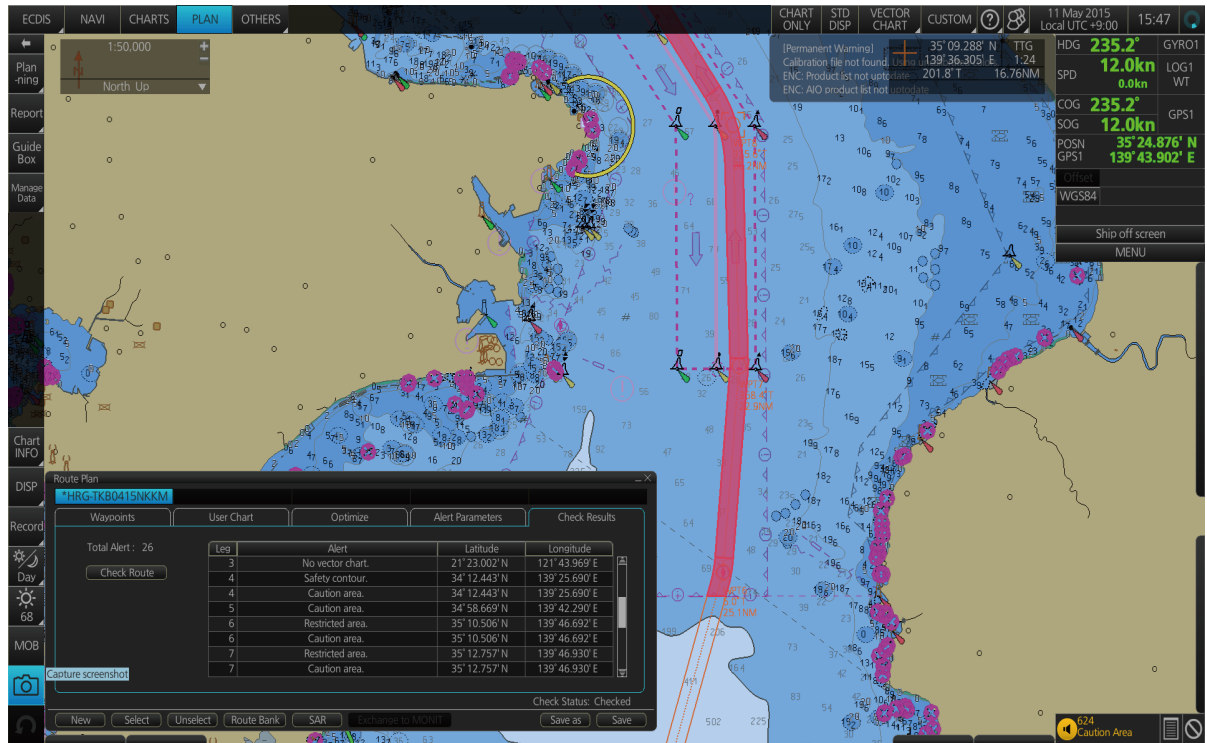

Sponsored by Japan Marine Science Inc.

Ref. 5 Sample Display of Route Monitoring
 (Off Track Alarm : Ship's position is 328m right side to Planned Route.)
 (Shoulder width of Planned Route : 200m, Total =400m Left and Right)

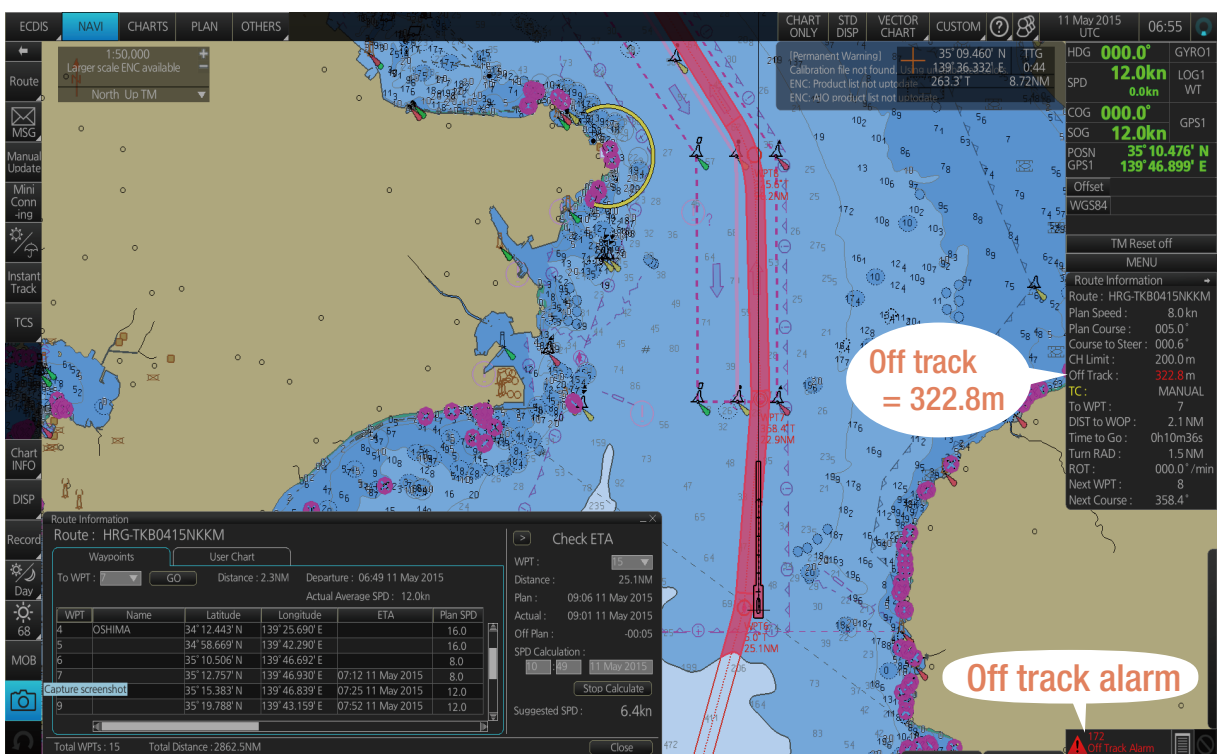

Sponsored by Japan Marine Science Inc.



ECDIS also has additional functions such as AIS (Automatic Identification System) and can capture radar information and use it to display information on other vessels (Information from ARPA (Automatic Radar Plotting Aids)) and superimpose radar images. This has been summarised in diagrammatic form in Figure 6.



Sponsored by FURUNO
AIS
FA-170

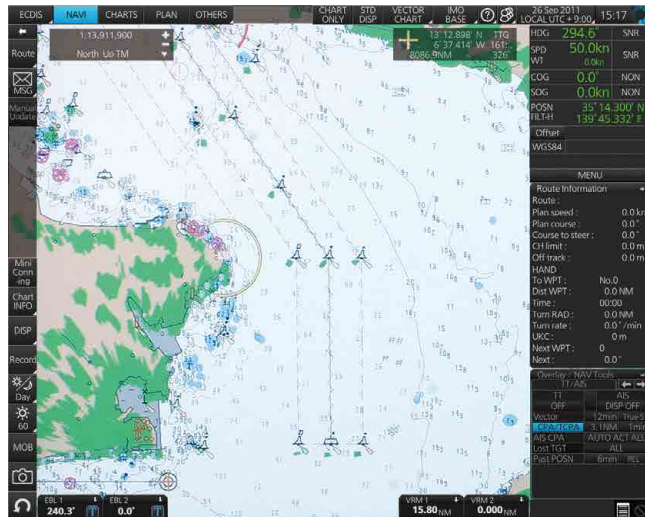

Sponsored by FURUNO
Radar Overlay

Figure : 6 Function of ECDIS

Basic Function

- Display of Nautical Charts
- Own Ship's Position data
- Display of Ship's Co/Speed
- Route Planning
- Route Monitoring
- Alarm and and Warning Display
- Record of Voyage

Additional Function

- Display of Other Vessels Information Data (ARPA Target Tracking)
- Display of AIS Information
- Radar Overlaid display
- Auto Pilot
- Display of Weather Information etc..

MSC.232(82) sets out the scope of ECDIS in the following terms: “The primary function of the ECDIS is to contribute to safe navigation.”

1 – 2 ECDIS Overview

The configuration of ECDIS is shown in Figure 7. Instead of the earlier paper chart, there is an electronic navigational chart: ENC. According to MSC232(82) 3.2, “Electronic Navigational Chart (ENC) means the database, standardised as to content, structure and format, issued for use with ECDIS by or on the authority of a Government-authorized Hydrographic Office or other relevant government institution, and conforming to IHO standards.”, the IHO being the International Hydrographic Organization.

The ENC is generally distributed through electronic media such as CDs/DVDs and may be bought from a chart distributor. Once the ENC is installed in the ECDIS, it is converted into a System ENC (SENC), and it is finally displayed on the screen.

A SENC is a database containing all the ENC contents and updated information created in the nautical chart format by the ECDIS manufacturer.

In other words, SENC is a source of information to implement display and other navigation related functions in ECDIS, and it is accepted as being equivalent to the latest version of the paper chart.

Figure : 7 Structure of ECDIS

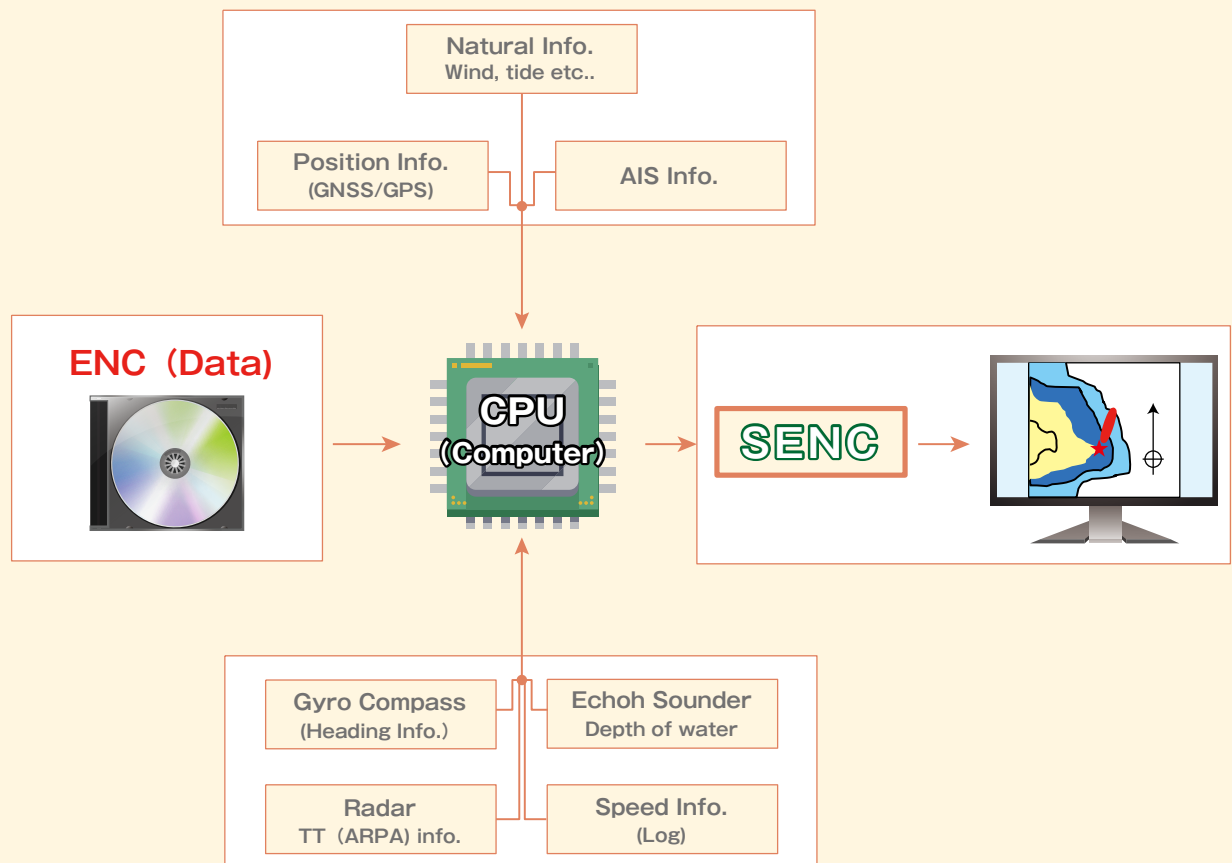



Chapter 2

Overview of Rules Regarding Electronic Charts

2 – 1 Nautical Charts for Navigation

Nautical charts for navigation are special-purpose maps which have been designed to meet the requirements of navigation at sea, and show diverse information such as the depth of water, material on the sea bed, land terrain, elevation of structures, the shape and characteristics of the beaches, hazardous objects and beacons, etc. In other words, nautical charts for navigation **provide images** of the relevant information to the navigator for safe navigation.

Until the arrival of electronic charts, information was provided in analogue format using paper charts, but now information is also available in digital format (Electronic Navigational Charts: ENC).

However, in some zones in the world, nautical charts based on old survey results are still used, and this affects the geodetic system in and positional accuracy of the nautical charts. Not all geodetic systems are accurately defined, and there are some inaccurate geodetic systems. In such ocean areas, please be aware that paper charts (and Raster nautical charts: See 3-3 for details) are not suitable for navigation using GNSS. This alert is being issued as a guideline in the IMO Ship navigation subcommittee circular “Ref. T2-OSSHE/2.7.1 SN.1/Circ.255 24 July 2006, Additional Guidance on Chart Datums and the Accuracy of Positioning on Charts”. (See Attachment ②)

2 – 2 The International Convention for the Safety of Life at Sea (SOLAS) Chapter V

SOLAS V/2 Regulation 2 Definitions

2.2 “Nautical chart” or “Nautical publication” is a special-purpose map or book, or a specially compiled database from which such a map or book is derived, that is issued officially by or on the authority of a Government-authorized Hydrographic Office or other relevant government institution and is designed to meet the requirements of marine navigation.*

* Refer to appropriate resolutions and recommendations of the International Hydrographic Organization concerning the authority and responsibilities of coastal States in the provision of charting in accordance with regulation 9.



SOLAS V/19 Regulation 19 2 Shipborne navigational equipment and system

(Old)

- 2.1 All ships irrespective of size shall have:
- 2.1.4 Nautical charts and nautical publications to plan and display the ship' s route for the intended voyage and to plot and monitor positions throughout the voyage. An electric Chart display and information system(ECDIS) may be accepted as meeting the chart carriage requirements of this subparagraph:

(Amended)

- 2.1 All ship irrespective of size shall have:
- 2.1.4 Nautical charts and nautical publications to plan and display the ship' s route for the intended voyage and to plot and monitor positions throughout the voyage. An electronic Chart display and information system (ECDIS) is also accepted as meeting the chart carriage requirement of this subparagraph. Ships to which paragraph 2.10 applies shall comply with the carriage requirements for ECDIS detailed herein;
- 2.1.5 Back-up arrangements to meet the functional requirements of subparagraph, 4, if this function is partly or fully fulfilled by electronic means.*

* An appropriate folio of paper charts may be used as a back-up arrangement for ECDIS. Other back-up arrangements for ECDIS are acceptable (see appendix 6 to resolution A.817(19) as amended.

Regulation 27 Nautical Charts and nautical publications

Nautical charts and publications, such as sailing directions, lists of lights, notices to mariners, tide tables and all other nautical publications necessary for the intended voyage, shall be adequate and up to date.

Chapter V of SOLAS defines the requirements for carriage of nautical charts in shipping vessels.

The above 3 rules indicate that the following requirements are met by the nautical charts carried in vessels corresponding to the vessel class.

- Official paper charts which have been kept up to date should be carried, or
- The latest version of the electronic navigational charts (ENC) should be used to provide a type approved ECDIS supplemented by appropriate backup measures (in accordance with the requirements to meet IMO performance standards).



2 – 3 Fitting Requirements

With the revision in Chapter V Rule 19 of SOLAS, which was adopted in June 2009, and came into effect on 1 January 2011, ECDIS is required to be used for each vessel category and size as shown in Table 8.

Table : 8 ECDIS Installation Schedule

ECDIS Installation Schedule

Category	Kind of ship	G/T	Deadline of installation								
New Build Vessels	Passanger	More than 500G/T	2012 July								
	Tanker	More than 3,000G/T	2012 July								
	Other than Tanker	More than 10,000G/T	2012 July	2013 July							
	Other than Tanker	3,000G/T ~ Less than 10,000G/T	2012 July	2013 July	2014 July						
Current Vessels	Passanger	More than 500G/T	2012 July	2013 July	2014 July						
	Tanker	More than 3,000G/T	2012 July	2013 July	2014 July	2015 July					
	Other than Tanker	More than 50,000G/T	2012 July	2013 July	2014 July	2015 July	2016 July				
	Other than Tanker	20,000G/T ~ Less than 50,000G/T	2012 July	2013 July	2014 July	2015 July	2016 July	2017 July			
	Other than Tanker	10,000G/T ~ Less than 20,000G/T	2012 July	2013 July	2014 July	2015 July	2016 July	2017 July	2018 July		

- * New Build vessel (Pax · Tanker) : Buidled after 1st July 2012
- * New Build vessels (Other than Tanker) : Buidled after 1st July 2013
- * Current vessel (Pax · Tanker) : Buidled before 1st July 2012
- * Current vessels(Other than Tanker) : Buidled before 1st July 2013

Chapter 3 Electronic Charts

An understanding of nautical chart data is necessary in order to use ECDIS. ECDIS is a system which displays electronic charts, and unless the user understands the kind of data displayed, the user cannot use ECDIS effectively. This chapter describes the basics of the electronic charts displayed in ECDIS.

3 – 1 Differences between the Electronic Chart System (ECS) and Electronic Chart Display and Information System (ECDIS)

First, it is important to understand the difference between ECS and ECDIS as systems which display electronic charts. (See Figure 9)

• ECS: Electronic Chart System

Equipment that can display electronic charts, but does not meet the IMO performance standards. (For example, if electronic charts are stored and displayed from a notebook PC, then that notebook PC is an ECS.)



• ECDIS: Electronic Chart Display and Information System

ECDIS refers to equipment that meets the performance requirements of IMO, and has obtained type approval from the flag state.

Figure : 9 ECS and ECDIS

ECS : Equipment that does not meet the IMO performance standards

ECDIS : Equipment that meets the IMO performance standards, and whose models have been certified by the flag state

3 – 2 Vector nautical Charts

A vector nautical chart is a digital database created by converting the positional information of all objects (points, lines, planes) displayed on a paper nautical chart into numerical form as co-ordinates. Therefore, objects displayed on a paper nautical chart are associated with geographical information.



Each page on a paper nautical chart is a square known as a “Cell”, which is enclosed by specific latitudes and longitudes. A cell is classified in 6 ways according to the purpose of navigation. (See Table 10. This classification has been done by the Hydrographic and Oceanographic Department, Japan Coast Guard, and the cell size as well as the scale of the nautical chart are left to the hydrographic organisation in each country.)

Table : 10 Category of Nautical Chart Scale

Category of Nautical Chart Scale

Purpose of Voyage	Scale	Cell Size
Overview	1 : 1,500,001 ~	8 degree, 25 degree
General Navigation	1 : 300,001~1 : 1,500,000	4 degree
Coastal Navigation	1 : 80,001~1 : 300,000	1 degree
Approach	1 : 25,001~1 : 80,000	30 minutes
Harbour	1 : 7,501~1 : 25,000	15 minutes
Berthing	~ 1 : 7,500	15 minutes

A vector chart which is an official nautical chart is known as an ENC (Electronic Navigational Chart), and its geodetic system is standardised as the world geodetic System : WGS-84.

As stated earlier, ENCs are official vector charts published by governmental authorities, or authorised hydrographic authorities, or other related government institutions, and are edited and codified based on the “IHO Specifications for the IMO Performance Standards for ECDIS”. They include a description of the data format, product specification for the production of ENC data, and an updating profile (S-57)” as specified by the IHO.

All vector charts other than ENCs are unofficial charts, and since they do not meet the carriage requirements of SOLAS nautical charts, they are not accepted as the basis information for navigation.

The geodetic system is based on WGS-84 as stated above, and it has direct compatibility with the Global Navigation Satellite System (GNSS).

Against this background, since ENC is a database which has been converted to numerical form based on the data in paper charts, the datum levels and units have been compiled in the same manner as a paper chart, but there have been considerable omissions in terms of inland areas found in the paper charts, such as the land terrain and geographical (natural and man-made) features required for piloting (or ground reference navigation).

Further, officially-updated information for mariners is usually provided in an “Electronic Notice to Mariners”, which is distributed in digital form, and can be downloaded from the website or provided as an Update CD/DVD.

As of August 2015, ENCs for almost all ocean areas have been created by the hydrographic authorities of various countries, but 100% worldwide coverage has not yet been achieved. When navigating through such ocean areas, Raster Navigational Charts (RNC) must be installed, as described later. In ocean areas where there are no RNCs either, paper charts need to be used.

In ocean areas covered by ENC, the IHO has provided an interactive web catalogue (<https://www.iho.int>), which shows the publication status of ENC worldwide.(See Ref.11)

Ref. 11 IHO ENC Catalogue Sample

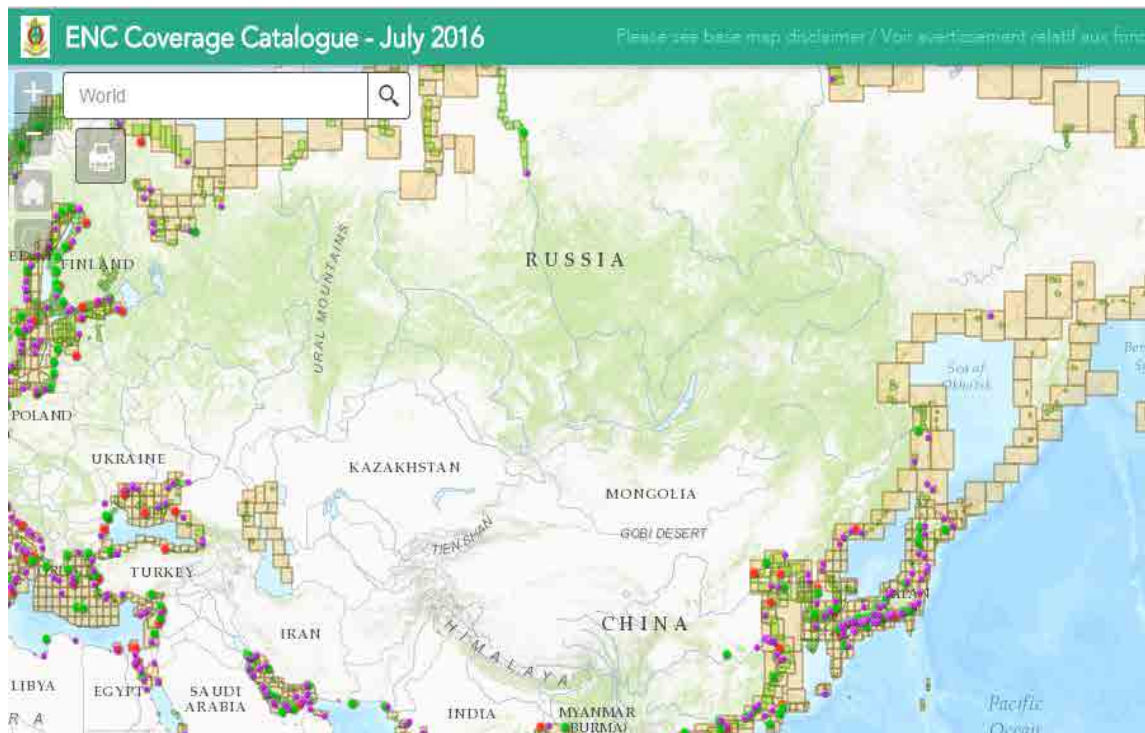

3 – 3 Raster Navigational Chart

A Raster Navigational chart refers to image data which has been obtained by capturing the existing paper chart using a scanner. The RNC is composed of pixels which have been generated in order to convert the information to image data, but this has not been associated with geographical information in the way that vector charts have. For example, the RNC has limitations such as the fact that geographical data such as water depth cannot be used to set alerts.

At present, in case of ARCS (Admiralty Raster Chart Service) provided by the UK Hydrographic Department, all the data is managed using the same number as the respective paper charts, and the scale used is the same as the paper charts.

Since there are ocean areas for which the geodetic system being used is not WGS-84, note that the geodetic system may be different from the one displayed by the position sensors (GNSS data) during use.

A Raster chart which is published by the government, hydrographic authorities authorised by the government, or other related government institutions, or officially published under their authority, similar to a vector chart, is known as a RNC (Raster Navigational Chart), and the others are all unofficial nautical charts. In short:

- A RNC is a type of copy of an official paper chart
- A RNC is created in accordance with international standards specified by the IHO
- A RNC is periodically kept up to date using official information, with updates provided/distributed in digital form.



In 1998, the IMO recognised the fact that it would take several more years to complete ENC's worldwide, and as a result, they are carrying out revisions to add the Raster chart display system mode (RCDS) to the ECDIS performance standards of IMO. (Further, as of the year 2016, worldwide coverage of ENCs has not yet been achieved.)

3-4 Differences between the Raster Chart Display System (RCDS) and Electronic Chart Information Display System (ECDIS)

As stated in 3-1, RNC and paper charts are used for navigation in areas not covered by ENC. Regarding the differences between RCDS and ECDIS, there is a requirement from IMO in the "IMO Safety of Navigation circular No. 207" (See the Attachment ③) that if ECDIS is used in RCDS mode, **"A suitable set of paper charts which has been kept up to date"** must be used in that ocean area.

A summary of the features of RNC is given below. Users are required to fully understand these features. (See Ref.12-1 and 12-2)

- 1 That RNC is a type of copy of an official paper chart.
As stated in 3-3, RNC is displayed in ECDIS by scanning a paper chart. Therefore, the information displayed is the same as the paper chart.
- 2 However, since it is not associated with geographical information in the way that a vector chart is, it cannot be used, for example, to set alerts based on geographical data such as water depth. (It is not possible to set grounding alerts).
If the user wants to include alert functions similar to a vector chart, he must manually enter the alert data.
- 3 A vector chart is a digital database created by converting the position information on all objects (points, lines, and planes) in the area into numerical form as co-ordinates, and hence detailed information on each object (for example, information on water depth, buoys, lighthouses, etc.) can be selected and checked. A Raster chart, however, only contains information from the displayed drawings.

Ref. 12-1 RNC Sample

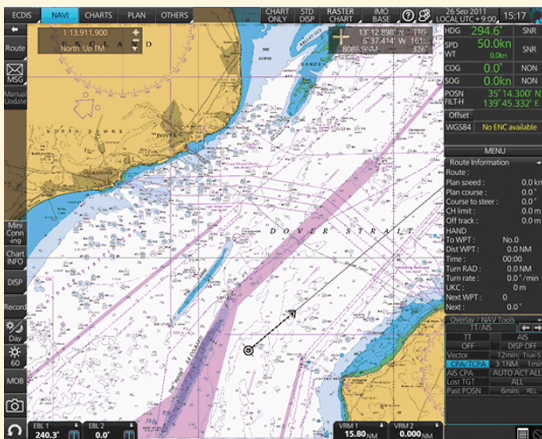

RNC : Copy of Paper Chart

Ref. 12-2 ENC Sample



ENC : Select Data for Display

Sponsored by FURUNO

An ENC uses a technique known as “Layering” to display the chart on the screen. This is an image obtained by displaying multiple transparent sheets with different information superimposed on a single screen. (See Figure 12-3)

Figure: 12-3 ENC Information Layer (Image drawing)

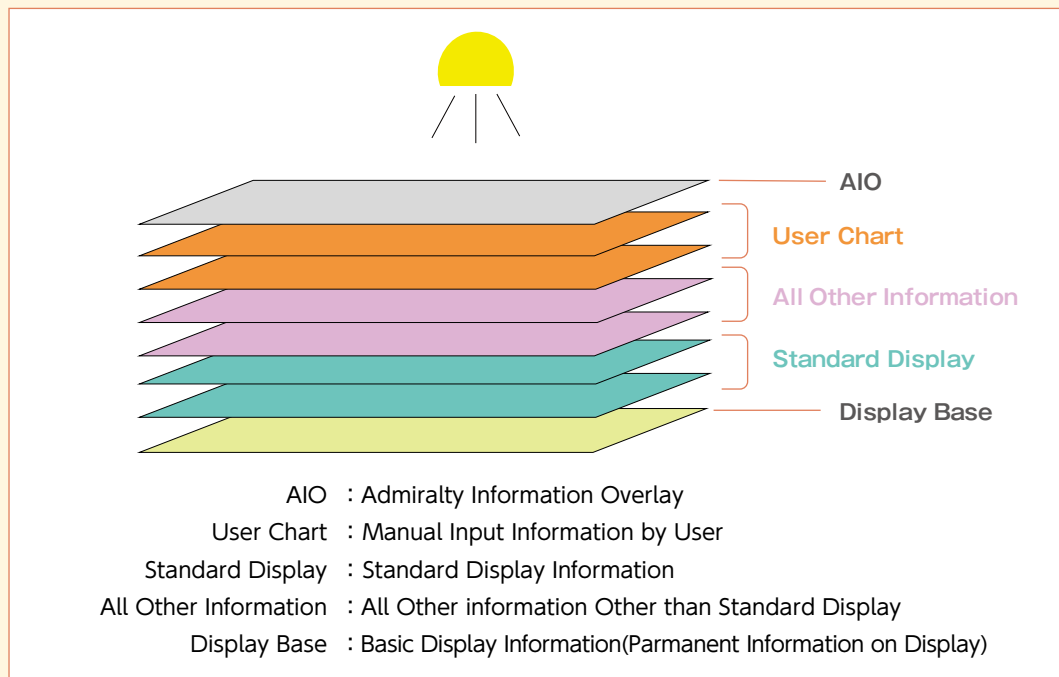

On the other hand, since RNC is a copy of a paper chart, it does not use the layering technique, but is viewed as an image on which a single electronic file is displayed, with superimposed on it other charts manually entered by the user. (See Figure 12-4)

For example, areas such as a no go area or “Captain call” position may sometimes be pencilled on a paper chart, and such a chart with additions made by hand is known as a user chart.

Figure : 12-4 RNC Display (Image Drawing)

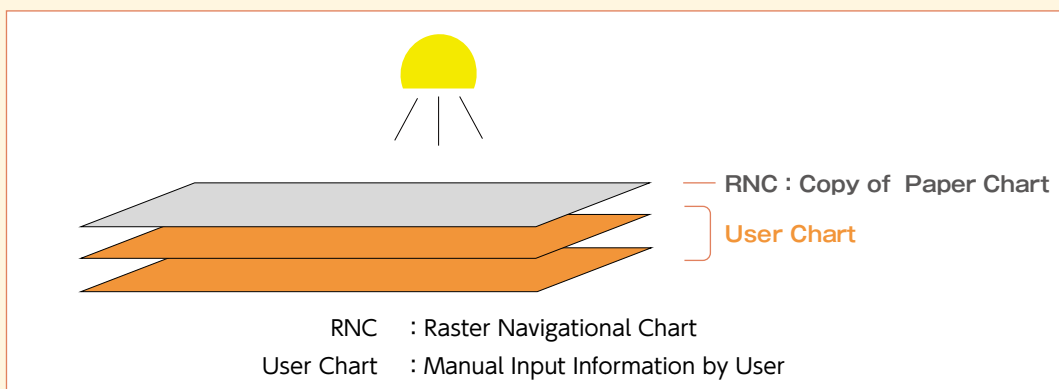

3 – 5 Classification of Official Charts and Unofficial Charts

There is considerable confusion regarding the name for the format when providing/distributing electronic charts. Figure 13 has been created in an attempt to clear up this confusion.

However, as can also be observed from Figure 13, it is clear that the same format is used to provide/distribute both official and unofficial nautical charts.

Figure : 13 Official · Unofficial Nautical Chart format (Sample)

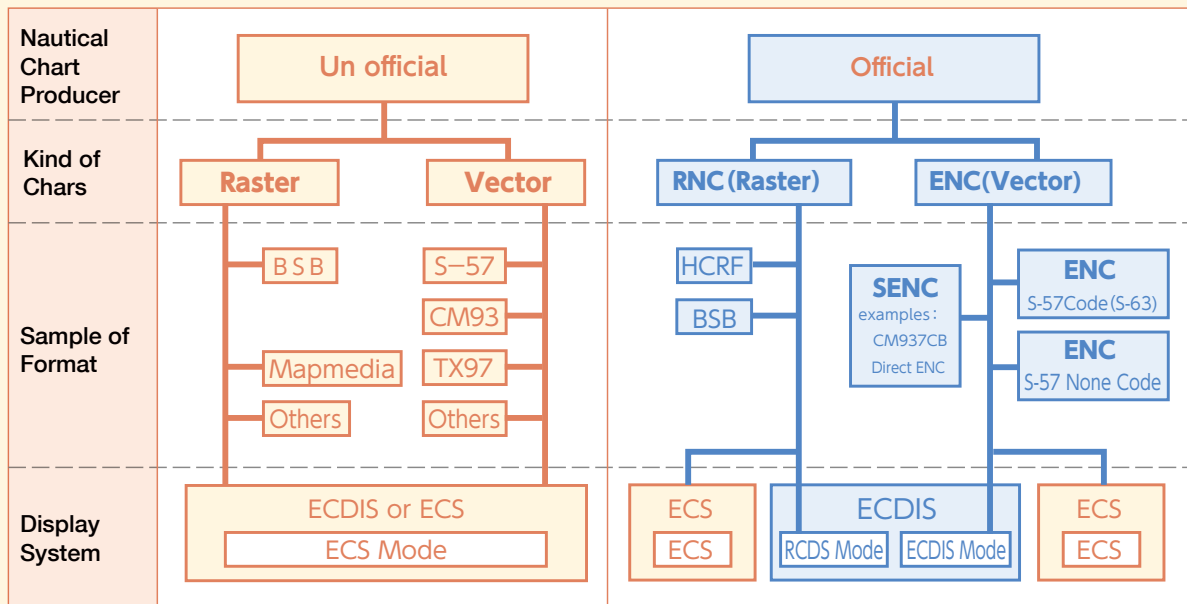

Note: In an unofficial source, even an ECDIS system will not switch to the ECDIS display mode. The portion shown in blue in Figure 13 is ECDIS.

Therefore, to determine whether or not the nautical chart is official, it is important to use the source documents since it is difficult to determine this using the format information. The creator must determine the situation and purpose for which the relevant nautical chart information is to be used, and must finally probe whether the combination of the relevant nautical chart information and the specific system functions operates as the ECDIS, or as a simple ECS.

3–6 Backups

Although a variety of electronic systems exist, there is no completely “Fail-safe system” which guarantees that the systems will never malfunction. Therefore, the provision of a backup system is required from the viewpoint of risk management. In IMO performance standards, the entire ECDIS system must have a complete and completely separate back-up. The following is stipulated with regard to back-ups :

- An independent facility which can ensure complete continuity of ECDIS functions in order to ensure that system malfunction does not lead to a gravely critical situation
- A means to carry out safe navigation using the remaining navigational components in case of ECDIS malfunction.

The IMO backup standards mentioned above refer to basic matters, with room for considerable flexibility, but the options for backup functions which are generally approved are the following :

- **A back-up ECDIS which is connected to an independent power source, and can be used to enter separate GPS positioning information.**
- **A set of paper charts which are suitable and kept up to date for the intended voyage.**

3 – 7 Approval by Port State Control (PSC)

When a vessel plying on international routes enters a certain port, it is subject to Port State Control (hereinafter referred to as PSC). PSC is enforced by the PSC Officer for that port with reference to the rules of the flag state and international conventions and rules, and nautical charts are one of the inspection items.

PSC in the EU is enforced according to the guidelines defined in the Paris MOU. However, ECDIS guidelines describe the inspection by the PSC Officer in terms of whether the vessel is using the proper electronic charts, based on the requirements of the SOLAS Convention. The inspection items are as follows :

- ☑ Whether the vessel is in possession of documents showing that its ECDIS is in compliance with IMO performance standards. If these documents are not on board, the PSC Officer can ask the flag state for confirmation that this system meets their legal requirements. (Certificates for type approval, etc.)
- ☑ Whether this system is mainly used for navigation. Check whether ECDIS is being used in the ECDIS mode or RCDS mode, or in both modes. (Fact-finding)
- ☑ Whether written documentation has been issued for this vessel in order to use ECDIS. (Whether the relevant documents are on board the vessel)
- ☑ Whether the master and duty officer can present proper documents to prove that they have undergone generic training and model-wise familiarisation training on ECDIS. (Whether the master and officers are in possession of certificates of completion of training. See Ref.14)
- ☑ Whether the ENC's (and RNC's) to be used on the intended voyage have been kept up to date. (Whether they have definitely been updated using the provided/distributed update information)
- ☑ Whether the vessel is equipped with approved backup measures which can safely transfer the ECDIS function if there is an ECDIS malfunction, and ensure safe navigation using the remaining navigation components. Also, whether the backup ECDIS is operating in the same manner as the main ECDIS, or if paper nautical charts are operating as the backup, whether nautical chart corrections have been correctly performed, and recorded.

Check

Ref.14 ECDIS Familiarization Training Certificate Sample



**Chapter 4****ECDIS Familiarisation Training****4-1 STCW**

The convention related to the qualifications of seafarers responsible for ship operation is STCW (International Convention on Standards of Training, Certification and Watch keeping for Seafarers 1978).

In 2010, the IMO's Standards of Training and Watch Keeping Sub-Committee was convened in Manila in the Philippines. Discussions took place on "Ensuring the flexibility of compliance with the convention, training using innovations in science and technology, qualification certificates and how to attain the required level of watch keeping". The convention was revised after this.

With reference to ECDIS, it was specified that "The following knowledge, understanding, and skills are required to use ECDIS in terms of handling a new technology". The following items ① and ② are the minimum standards of proficiency in the STCW Convention for 2nd officers and 3rd officers. In addition, minimum standards of proficiency have been determined for the master and chief officer as well. (See Attachment ⑤ STCW Table A-II/2 Extract)

① ECDIS operational capability and knowledge of its limitations including the following matters

- Complete understanding of electronic navigational charts (ENC), data accuracy, display rules, display options, and other nautical chart data formats
- Risks of overdependence
- Familiarisation with ECDIS functions as required by existing performance standards.

② Familiarisation with ECDIS operation and interpretation and analysis of information obtained from ECDIS, including the following :

- Use of functions which are integrated with other navigational systems, including correct operation and adjustment to the proper settings
- Safe monitoring and co-ordination of information on the ship's position, display of navigation area, motion mode and bearings, displayed nautical chart data, route monitoring, information layer created by the user, other vessels that have been seized (If connected to AIS and/or radar tracking (ARPA)), and the radar overlay function (if connected)
- Checking the vessel position using other methods
- Efficient use of various settings including prevention of grounding, alert parameters when the vessel is approaching another vessel or special navigation areas, completeness of nautical chart data, update status of nautical charts, and backup measures, according to the operating procedures.
- Proper settings and adjustment of settings according to the current situation

- Awareness of the situation while ECDIS is in use, including the situations where the vessel is approaching a safe water area or hazardous water area and information regarding direction and speed of the current, selection of nautical chart data and scale, correctness of the route, detection of other vessels and dealing with them, and status of sensor maintenance.

These capabilities can be proved by the evaluation obtained from one or more of the following: “Approved training ship experience”, and “Approved ECDIS simulator training”.

4-2 Familiarisation Training

With regard to ECDIS operation, both the STCW Convention and the ISM Code specify that “Complete and appropriate training is required for correct and safe use of ECDIS”, and it is recommended that the training should consist of a total of 40 hours of lectures and simulator training (8 hours x 5 days).

In addition, the governments of various countries strongly require that the master and officers engaged in navigational watch duties should be in possession of certificates of completion of ECDIS training. ECDIS familiarisation training is broadly classified into the following 2 types:

- ① **Generic training - According to the STCW Convention 2010 Manila amendments**
- ② **Model-wise training - According to the ISM code/STCW Convention**

Further, the guidance regarding switching from navigation using paper charts to navigation using ECDIS has been issued by the IMO Safety of Navigation circular Ref. T2-OSS/2.7.1 SN.1/Circ.276 (10 December 2008) “Transitioning from Paper Chart to Electronic Chart Display and Information Systems (ECDIS) Navigation”. (See Attachment ④)

4-2-1 Generic Training

IMO has approved “The IMO Model Course 1.27 (Model course on Operational Use of Electronic Chart Display and Information Systems ECDIS)” in order to understand the capabilities, characteristics and limitations of ECDIS, and to learn how to use and operate ECDIS correctly. At present, the training program being conducted follows the “IMO Model Course 1.27 (2012 Edition), which is the version certified by the 2012 IMO/STCW subcommittee”.

This training covers all matters concerning safety during ECDIS operations as well as knowledge of the entire system, and describes matters that must be learnt by trainees before they can obtain the ECDIS training certificate.



Generic Training

:Sponsored by Japan Marine Science Inc.



The certificate for education and training on ECDIS must record and clearly state the following:

- ▶ The certification candidates should have completed the training course on ECDIS operating methods based on the IMO Model Course 1.27.
- ▶ The training course should meet the requirements of IMOSTCW-95 “International Convention on Standards of Training, Certification and Watch keeping for Seafarers (STCW Convention)” .

4-2-2 Type Specific Familiarisation Training

Trainees are required to familiarise themselves not only with the overall details regarding the operation of ECDIS, but with details of the model being used as well. They are thus required to undergo not only generic training, but type specific familiarisation training as well. Specifically, in AMSA (Australian Maritime Safety Authority), all masters and officers are required to be in possession of certificates of completion of Type Specific Familiarisation Training, which is familiarisation training on the on-board ECDIS (Familiarisation training provided by the ECDIS manufacturer). The authorities of other countries may have similar requirements.

4-2-3 Training Facility

The facility/institution conducting the ECDIS training shall conduct it after being certified by the government or an authorised institution (such as a Classification Society). The facility/institution shall issue a certificate of training completion attested by the government or an authorised institution. As of the year 2016, type specific familiarisation training does not require a completion certificate to be issued by the government of each country. Instead, the training facility issues a certificate of completion attested by Classification Society.



Familiarization

:Sponsored by Japan Marine Science Inc.

Chapter 5

Handling of Electronic Charts from the Viewpoint of Masters and Officers

So far, various nautical instruments on the vessel bridge have been providing information independently to the Conning Officer. Now, with the introduction of ECDIS, the information obtained from these nautical instruments is stored in ECDIS. (See Figure 15)

Figure : 15 ECDIS and other Nautical Equipment

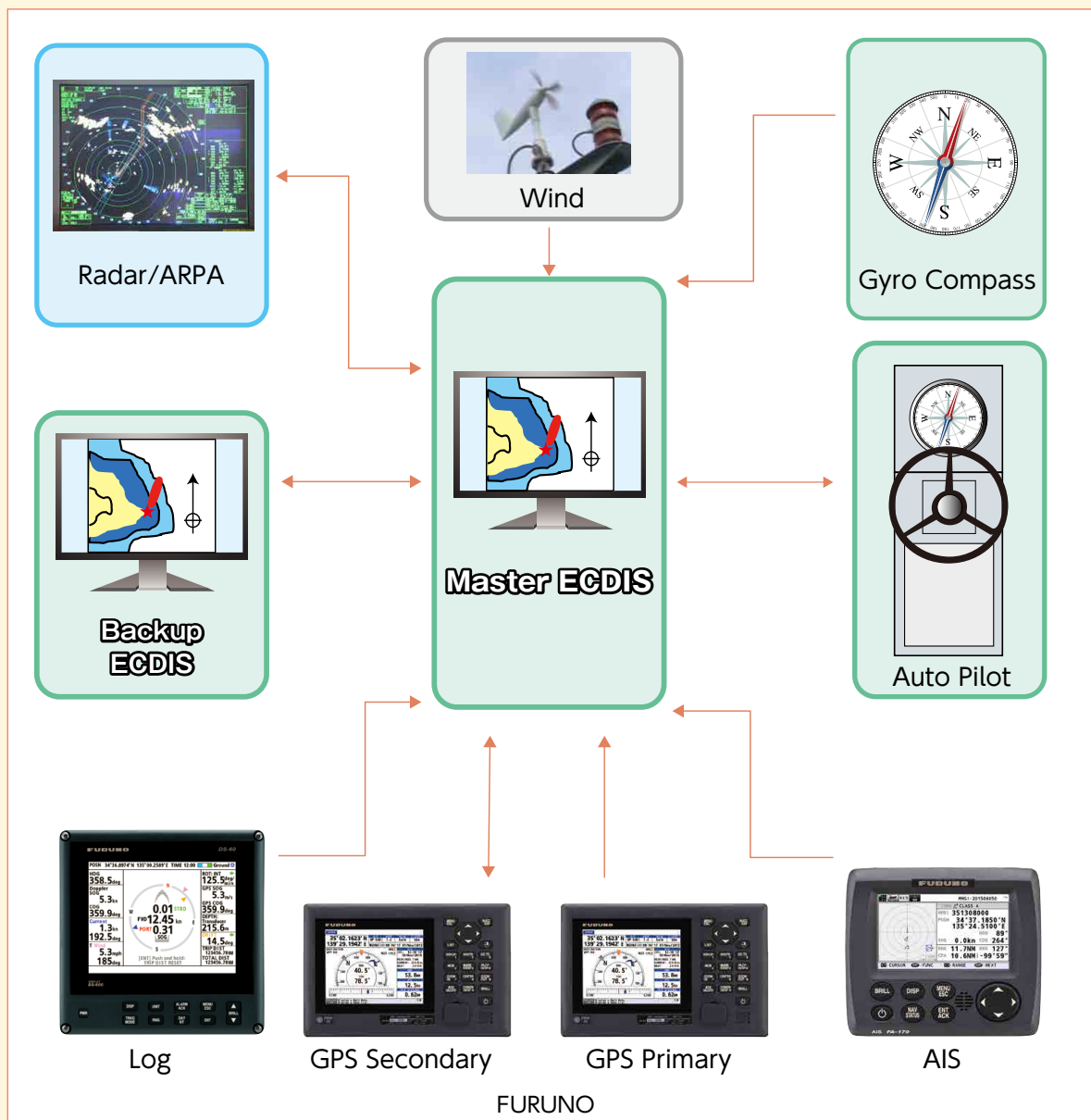



For example, after checking the vessel name and movements from AIS for hazardous vessel information displayed in ARPA, the intentions of the vessel used to be determined using VHF, if required. Then after confirming the compass reading, and steering to avoiding collision on Auto Pilot, the LOG display was checked to find the trend in changes in speed, and the display on the wind direction meter and anemometer was checked to determine the relative wind direction and wind speed and examine whether there were any problems before and after collision avoidance manoeuvres. The position of the vessel was checked using radar, GPS and target bearings to check for any problem in the manoeuvring of one's own vessel, or checking for deviation from the planned course, then entered in the paper chart.



Sponsored by FURUNO
Doppler Sonner

The conventional approach, where the Conning Officer would check each piece of information generated by each individual nautical instrument and organise it mentally before using it for manoeuvring may gradually change to an approach where all the information obtained by viewing the ECDIS screen may be treated the same as information actually gained using the human eye, and used for manoeuvring.

In other words, ECDIS can be considered as an integrated navigation system (INS) that is extremely information-intensive and is set up on the bridge for the automated operation of the vessel.



Sponsored by FURUNO New Generated Bridge System Voyager

5-1 Human Errors due to Overdependence

ECDIS is one of several useful nautical instruments, but if it is not used correctly, the risk of serious accidents such as collision or grounding arises. With the rapid advancements in computing technology we are seeing in recent times, there is a feeling that people are tending to trust computers excessively. However, computers merely use programs to perform calculations based on data that has been entered, and display the results only, and cannot judge whether the entered data is correct. Thus, if wrong data is entered, the result that is output and displayed is based on calculations performed using wrong information.

If we check and compare against “Human traits” (For details, see “Thinking Safety” in the Loss Prevention Bulletin No. 35 of our Club), we find that more human errors are caused by misinterpretation of information displayed on ECDIS, and this implies that the use of ECDIS leads to hazardous situations.

From our knowledge of human behavioural traits, let us consider the nature of risks caused by overdependence on ECDIS. Human behavioural traits (Table 16), and the information processing (Figure 17) that takes place when acting based on human traits are shown below.

Table: 16 Human Characteristics

Twelve Human Characteristics from Web "ANZEN NO KOMADO"

Human Characteristics			
①	People beings sometimes make mistakes	⑦	People beings are sometimes in a hurry
②	People beings sometimes careless	⑧	People beings sometimes become emotional
③	People beings sometimes forget	⑨	People beings sometimes make assumptions
④	People beings sometimes do not notice	⑩	People beings are sometimes lazy
⑤	People beings have moments of inattention	⑪	People beings sometimes panic
⑥	People beings sometimes are able to see or think only one thing at a time	⑫	People beings sometimes transgress when no one is looking

Figure: 17 Human Characteristics : Information Processing in case of taking action

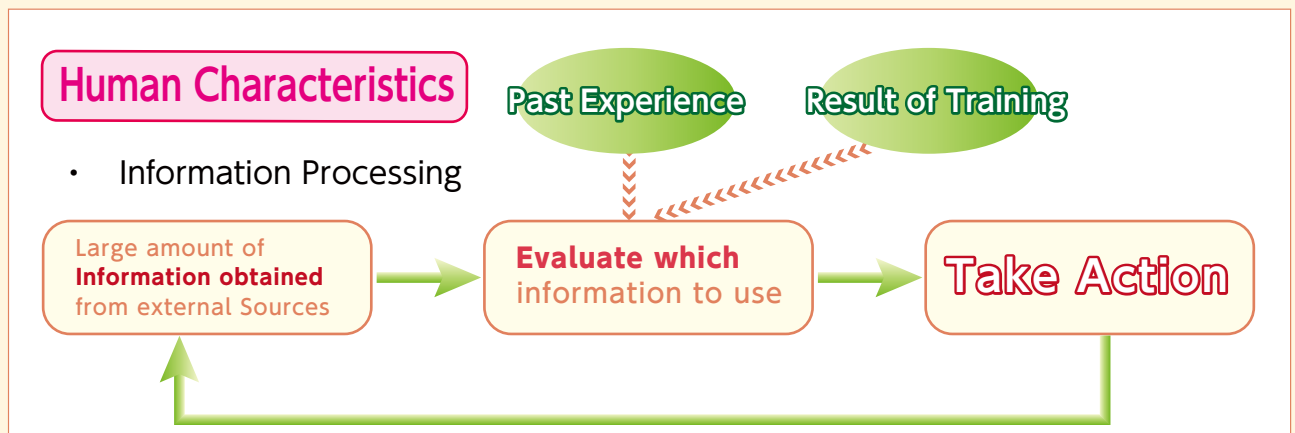

Approximately 90% of all maritime accidents are said to be caused by human error, and there are 12 human behavioural traits that lead to such human errors. The information processing that takes place when a person makes a move is as shown in Figure 17. A large amount of information is obtained from external sources and compared with past experience and what has been learned in training in order to select the required information. Once the person makes a move, new information appears, thus the process keeps on repeating. But if the wrong information is selected due to one or more of 12 behavioural traits, human error occurs, leading to an accident or problem.

The changes in human behavioural traits of the concerned persons before and after the introduction of ECDIS are summarised in Figure 18. The behavioural traits described in points ③ , ⑥ , ⑧ , ⑨ , ⑩ and ⑪ are thought to lead to increased risk.



Table: 18 Comparison table of Human Characteristics Before/After ECDIS Implementation

Human Characteristics				
Characteristics		Before ECDIS	After ECDIS	Evaluation
①	People beings sometimes make mistakes	○	○	No Changed
②	People beings sometimes careless	○	○	No Changed
③	People beings sometimes forget	△	○	Risk Increased
④	People beings sometimes do not notice	○	○	No Changed
⑤	People beings have moments of inattention	○	○	No Changed
⑥	People beings sometimes are able to see or think only one thing at a time	△	○	Risk Increased
⑦	People beings are sometimes in a hurry	○	○	No Changed
⑧	People beings sometimes become emotional	△	○	Risk Increased
⑨	People beings sometimes make assumptions	△	○	Risk Increased
⑩	People beings are sometimes lazy	△	○	Risk Increased
⑪	People beings sometimes panic	△	○	Risk Increased
⑫	People beings sometimes transgress when no one is looking	○	○	No Changed

The comments below are numbered according to above table.

③ People may become forgetful

When using paper charts to check the vessel's position, Masters and Officers may unconsciously check the status of the compass or log too. But in the case of electronic charts, they may overlook important information because they are checking the information on the screen.

⑥ Eyes and thoughts are focused only on one object

Excessive concentration on the electronic chart screen may lead to neglect of the lookout, which is actually of the greatest importance.

⑧ People may get carried away by emotions

Excessive concentration on the electronic chart screen tends to reduce conversation between the crew keeping watch. If work is hampered due to such reasons, there may be emotional exchanges between those keeping watch on the bridge.

⑨ People may have subjective biases

For example, even though Masters and Officers are fully aware that the water depth stated in the nautical charts incorporates some error element, there is a tendency to place excessive trust in the information displayed in digital images.

⑩ People may be lazy and shirk work

Digitisation of information on the ship's course and speed may lead to blind trust in these numbers, whereas before the introduction of electronic charts, the information generated by each nautical instrument was processed mentally and used to arrive at a judgement.

⑪ People may panic

If the ECDIS display disappears for some reason, panic may ensue. As a result, excessive concentration on the recovery of ECDIS tends to divert the attention of Masters and Duty Officers/Crew on the bridge from "Lookout" duties, which is the main task of the navigational watch.

The 131st Lecture of the Japan Institute of Navigation (held on 31 October and 1 November 2014), and the Japan Institute of Navigation Lecture proceedings, Volume 2, Issue 2 dated September 30, 2014 included a paper entitled “Effectiveness and safety of navigational support using 「ECDIS」 (Noriko Nishii (National Institute of Technology, Toyama College)”. An extract from this report is reproduced below. (From the Navigational Sciences No. 28-85 Reprinting permitted on September 26, 2016 with permission from the Japan Institute of Navigation)

**Excessive trust on “ECDIS” and the trends among younger personnel:
Japan Institute of Navigation Lecture proceedings, Volume 2, Issue 2 dated September 30, 2014: Effectiveness and safety of navigational support using “ECDIS”**

In the ship personnel training facility, lectures on “ECDIS” were started in 2014 in order to meet “ECDIS” proficiency standards. In an on-board training ship fitted with “ECDIS”, a watch-keeping or manoeuvring simulator is used for exercises on avoidance manoeuvres. But trends different from before are being observed in students of late. By adding information from GPS, AIS, and radar, we are able to see that “ECDIS” is being perceived and operated in the same manner as a car navigation system or a PC or smart phone. The car navigation system

is akin to “ECDIS” in that it displays the current position accurately using information from the GPS, 3D Gyro, vehicle speed, and VICS, and it can accurately calculate and display the distance to the destination and estimated arrival time. As a result, there are many students who believe that it is possible to navigate the vessel using “ECDIS” alone. This trend is also seen in young officers, who tend to be overly dependent on systems such as ECDIS and AIS. Many veteran officers complain that the visual lookout is being neglected.

This writer has sailed as Master on several vessels fitted with ECDIS. Once ECDIS has been installed, my experience is that not only is there a drop in the number of times young officers use binoculars to check the movement of other vessels, they also spend more time simply standing in front of the ECDIS. Sometimes the less experienced officers even commence avoidance manoeuvres without using their own eyes to look at what is happening in front of them.

5-2 Objectives of ECDIS

The following objectives are defined in IMO MSC.232(82) Scope of ECDIS.

The primary function of ECDIS is to contribute to safe navigation

Paper charts are used for planning a route and checking the vessel’s position when navigating that particular route, or judging whether something can be safely avoided when performing an avoidance manoeuvre. Thus, the main objective of paper charts appears to be the prevention of groundings and the selection of the shortest and best sailing routes. We believe that Masters and officers should not expect that electronic charts will add any value to what was provided by paper charts.

ECDIS is one of “all the available means that are appropriate for the situation at that time” according to Clause 5 (Lookout) and Clause 7 (Risk of collision) in the Act for Preventing Collisions at Sea.

However, Trust in ECDIS data should not mean neglecting the basics of preventing collisions, such as visual confirmation of the area around the ship, checking radar information, and observing changes in the bearings of other vessels.

However, when I was sailing as Master in vessels fitted with ECDIS, as I have described earlier, I observed that young officers in particular would not even carry binoculars, or step away from their position in front of the electronic charts, or



perform visual lookouts. Even when performing avoidance manoeuvres, they would not confirm the compass readings before giving instructions to the helmsman. Excessive concentration on ECDIS operations also led to a lack of attention being paid to the reports of the helmsman, with the officers completely immersed in the ECDIS screen.

This situation points to a collapsed BTM (Bridge Team Management), which poses a threat to the safe operation of the vessel.

5-3 BTM and ECDIS

BTM is a **practical management** technique in which **team members** on the bridge use **various resources** during navigation of the vessel for **systematically** achieving safe operation based on **clear standards**. (See Figure 19)

Figure 19 BTM

- Team members** All personnel on the bridge
- Various resources** Human and physical resources
- Clear standards** Standards regarding factors such as navigation plan, rules, guidelines from the company and master of the vessel
- Organisation** Establishment of an efficient organisation structure including the company
- Practical** Management consisting of training using a simulator management techniques

In other words, this is a management technique that considers everyone on the bridge as part of a team, and demonstrates effective teamwork so that individual lapses do not directly result in accidents.

Needless to say, the first responsibility and role that must be fulfilled by the team on the bridge is the achievement of safe operation. In order to fulfil this responsibility and role, resources including personnel must be utilised.

The article titled “Thinking Safety” in the Loss Prevention Bulletin No. 35 published by our Club in July 2015 compared BRM (Bridge Resource Management) and BTM. BRM and BTM may be described as follows :

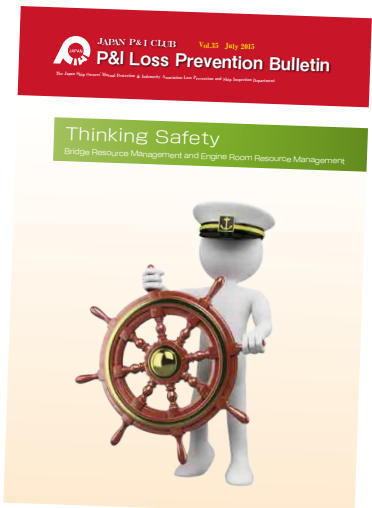

BRM

Has the objective of promoting effective utilisation of resources including people, and applies to the management functions that should be performed by the leader of the team that has been organised for effective utilisation of human resources.

BTM

To achieve safe operation, the efforts of the leader alone are not enough, and there must be increased activity by all the members belonging to the team. BTM is the management that recognises that improvement of the functioning of all the team members, including the leader, is indispensable, and works to achieve this.

In other words, both BRM and BTM have the same objective, and I believe that there is no need to differentiate between them.

BRM (Bridge Resource Management) emerged from the concept of CRM (Cockpit Resource Management) in the airline industry. “The Tenerife tragedy” of 1977 led to CRM training being implemented by airlines across the world since 1980. However, BTM training has been conducted since 1977 by the then Warsash Maritime Centre in the UK. At present, BTM and BRM are known by different names depending on the relevant rules and training facilities in each country, and there seems to be no point in debating about their definitions or differences.

(Practical Navigator: Scientific work from Japan Marine Science Inc., Edited by Capt. Hiroshi Sekine, and published by Seizando Shoten Publishing Company Limited)

The main objective of BTM is to eliminate individual human error to ensure that all the team members on the bridge are always conscious of safe operation of the vessel. For example, the pilot on board must also be considered as a supporting member, as he plays an important role on the bridge. At the same time, the crew must also understand that, while on the bridge, it is their team’s responsibility to assist the pilot.



Sponsored JAPAN CAPTAINS' ASSOCIATION
DVD [For Effective Practice of the BRM]

Most accidents while the pilot is on board happen because manoeuvring is left completely to the pilot, and the crew working under the master do not perform their duty of lookout. Instead, they but act only when instructed by the pilot. At this point, it can be determined that BTM has failed, including the pilot’s involvement.

To ensure that an error by a single individual does not create a hazardous situation, it is necessary to spot the error quickly and work as a team to support one another and correct it.

Merely because ECDIS has been put into use does not mean that a basic safe operation system has been achieved. This concept of BTM is shown in Figure 20.

Figure: 20 Concept of BTM

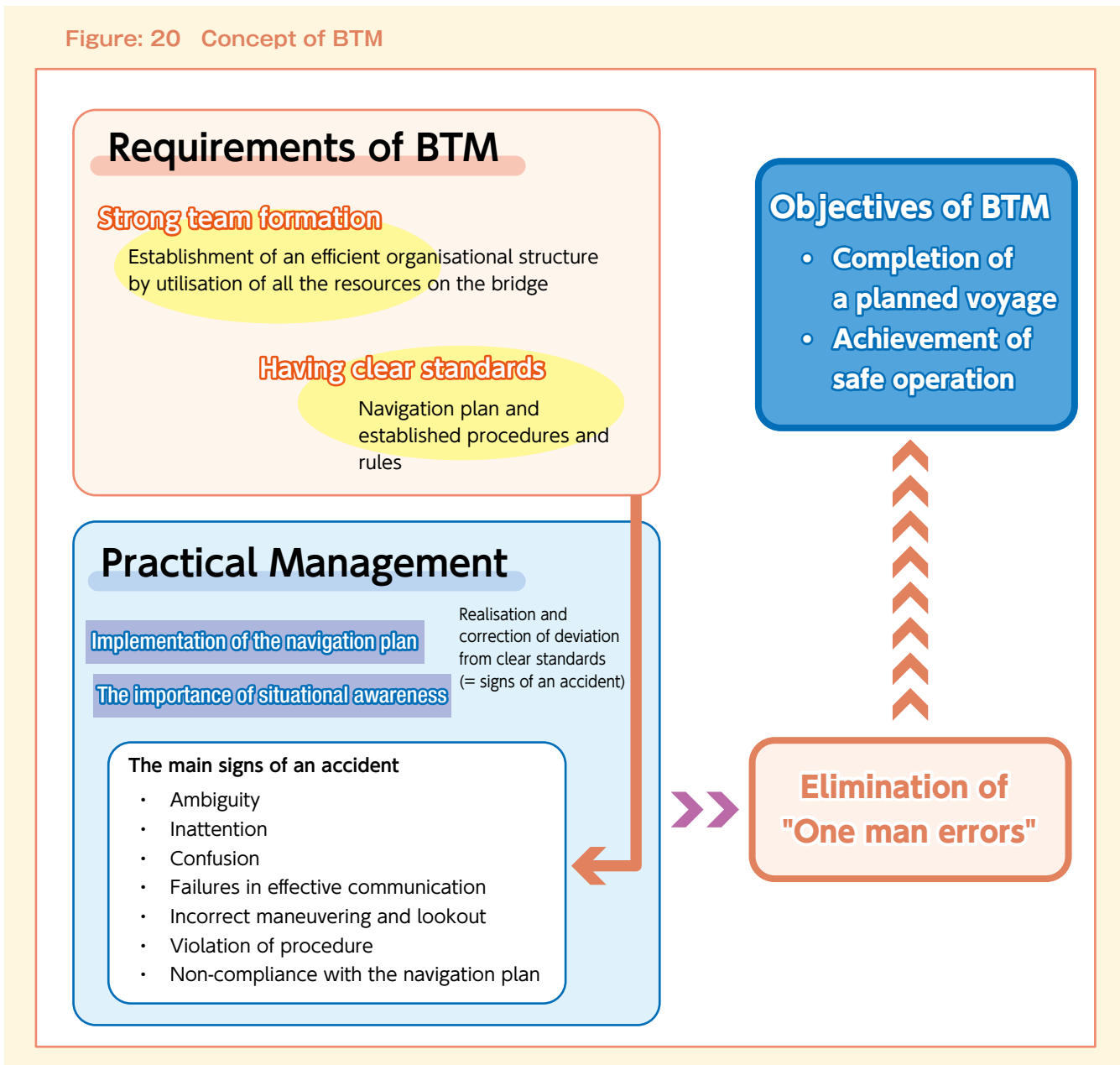

Further, the relation between the resources is as shown in Figure 21 (M-SHELL model), where communication is not limited to “Person” to “Person” alone, but also exists between “Person” and “Software (S: the so called documents)” or “Hardware (H: Equipment)” or “Environment (E: External information)”. If successful communication is established between each pair of resources, all the resources amalgamate well to build a good relationship, leaving no room for error.

But, as soon as communication fails, the resources get easily separated and a gap forms between them. These gaps increase the probability of human errors, and as a result, invite accidents (problems).

From the viewpoint of this M-SHELL model, ECDIS information is one of the pieces of information transmitted by H (Hardware), and is just one of the resources available on the bridge.

Figure : 21 M-SHELL Model



However, excessively trusting ECDIS information, or speaking only to ECDIS, leads to unsatisfactory communication with information generated by persons (L), software (S), and equipment (Hardware (H)), thereby obstructing the conversation with each of these resources. This excessive trust not only leads to a communication gap with ECDIS but also with other resources.

In case Masters and Officers have excessively trusted the data without realizing that wrong information has been entered into ECDIS, no meaningful conversation is possible with ECDIS, and gaps are left in communication.

For example, cases have been reported where the alert settings for information on water depth and draft have been wrongly entered, with the mistakes not noticed. As a result, the alert was not issued, the vessel entered shallows which were not navigable and grounded.

Masters, Officers and other Bridge team members **must not forget the basic aim of BTM which is to establish good communications with each resource and to prevent errors due to gaps in communication.**

Show Figure 22 and 23 : the image of Bridge Before/After ECDIS



Figure : 22
Before ECDIS introduction

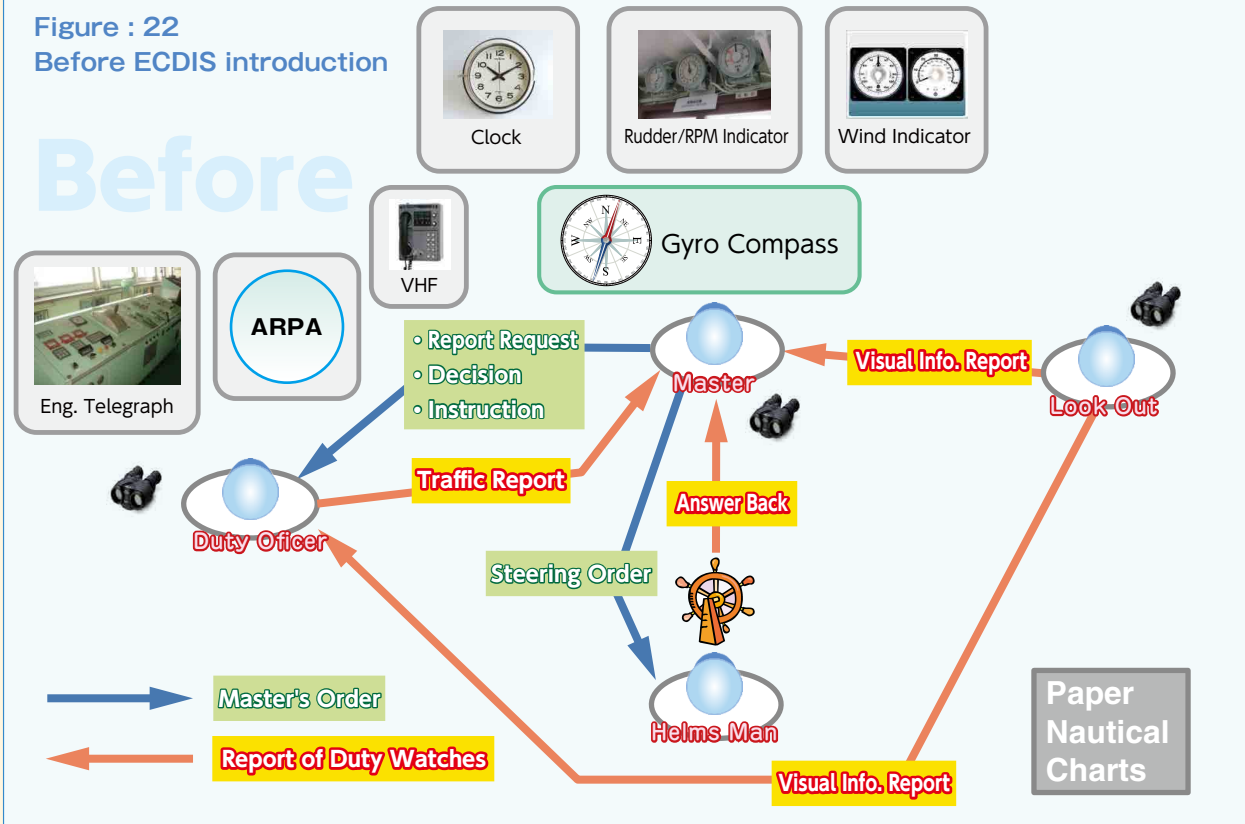
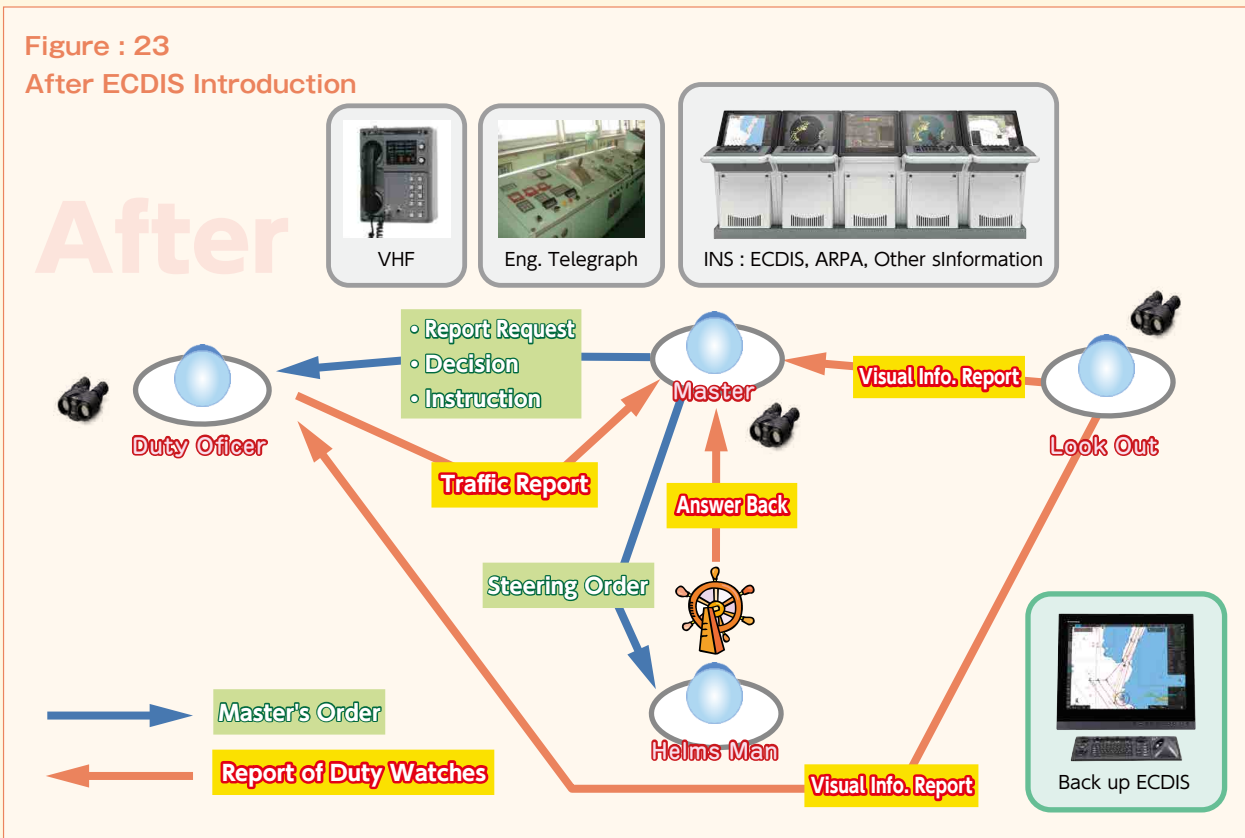

Figure : 23
After ECDIS Introduction



5-4 ECDIS Information Management

Many Electronic Chart Display and Information Systems (ECDIS) that have been fitted so far use Windows XP as the basic software. Anti-virus support for Windows XP has now ended, and it appears to be vulnerable to computer virus attacks. For example, data on the route plan is sometimes stored on personal USB devices. But to keep ECDIS safe from computer viruses, it is necessary to send text messages to the crew to inform them not to upload data from their own USB devices, and to formulate provisions for Safety Management Regulations.

Conclusion

ECDIS has significantly changed conventional navigational watch-keeping methods, and may arguably be termed as a navigational watch revolution.

However, Master, Officers and other Bridge team members must understand that trouble will not be far away if they make a single mistake when evaluating the information displayed by ECDIS or using ECDIS without completely understanding the ECDIS configuration.

In any case, as their dependence on such a convenient system increases, they must not forget that since the information being displayed is a digital display. If the team blindly accepts the displayed numbers, and does not continuously monitor them or compare them with the information obtained from other nautical instruments, and as a result makes a wrong judgement, the trouble caused will have a much larger impact on safe operation than the trouble caused by mistakes using other nautical instruments. Masters, Officers and other Bridge Members must also not forget that there may be sudden IT troubles such as the screen hanging or a sudden shut-down of the system, as experienced with PCs and other electronic devices.

As described in 5-4 ECDIS Information Management, it is a “person” whose actions end up introducing viruses into a computer system. Hence, one must also build methods to prevent the invasion of these computer viruses.

Further, it is necessary to remind ourselves that lookout is the basis of the navigational watch, and the Bridge members using ECDIS must have complete knowledge of the system and pay close attention to it.



Attachments

No.	Reference name
①	ANNEX24 Resolution MSC.232(82) "Performance standards for Electric Chart" Display and Information System (ECDIS): IMO Resolution MSC.232(82) Electronic Charts https://www.nauticalcharts.noaa.gov/staff/docs/IMO_MSC.232(82)ECDIS.pdf
②	Ref. T2-OSSHE/2.7.1 SN.1/Circ.255 (24 July 2006) "ADDITIONAL GUIDANCE ON CHART DATUMS AND THE ACCURACY OF POSITIONS ON CHARTS": IMO Safety of Navigation circular: Guidance on chart datum's and accuracy of positions on charts http://www.ecdis.it/Normativa/IMO%20SN.1_Circ%20255.pdf
③	Ref. T2-OSS/2.7 SN.1/Circ.207/Rev.1 (22 October 2007) "DIFFERENCES BETWEEN RCDS AND ECDIS": IMO Safety of Navigation circular: Differences between the Raster Chart Display System (RCDS) and Electronic Chart Display and Information System (ECDIS) https://www.iho.int/mtg_docs/industry/ECDIS_workshop_12-3/SN.1-Circ.207-Rev.1%20-%20Secretariat.pdf
④	Ref. T2-OSS/2.7.1 SN.1/Circ.276(10 December 2008) "TRANSITIONING FROM PAPER CHART TO ELECTRONIC CHART DISPLAY AND INFORMATION SYSTEMS (ECDIS) NAVIGATION": Guidance on switching from "navigation using paper charts" to "navigation using ECDIS" https://www.iho.int/mtg_docs/International_Organizations/IMO/ECDIS-ENCDocuments/English/SN_Circ276.pdf
⑤	STCW Convention Table A-II/2 Extract

References

We were provided with several documents and reference materials during the publication of this Loss Prevention Bulletin. We are deeply grateful to everyone who has provided us with these materials.

- **Published by Japan Hydrographic Association**

S-66 Facts about Electronic Charts and Carriage Requirements; Provisionally translated Japanese version (published in February 2010)

http://www.jha.or.jp/jp/jha/purchase/pdf/guide_00.pdf

Note: The above document contains a provisional Japanese translation of Attachments ② to ④.

- **Japan Institute of Navigation**

Japan Institute of Navigation Lecture proceedings of the 131st Lecture (October 31 and November 1, 2014), Volume 2, Issue 2 dated September 30, 2014: Effectiveness and safety of navigational support using "ECDIS"

<http://members.j-navigation.org/jkouen/doc/k00202/k00202023.pdf>

- **Japan Marine Science Inc.**

ECDIS Training Material

- **Seizando Shoten Publishing Company Limited, "Practical Navigator" Scientific work from Japan Marine Science Inc.; Edited by Master Mariner Capt. Hiroshi Sekine**

- **Kaibundo "The training textbook for Electronic Chart Display and Information System"; Edited by ECDIS Study Group, Marine Technical College**

- **All the photographs of navigation equipment are by courtesy of FURUNO**

- **Japan Captains' Association :** Photograph

Attachments ①
ANNEX24 Resolution MSC.232(82) "Performance standards for Electric Chart" Display and Information System (ECDIS): IMO Resolution MSC.232(82) Electronic Charts

添付資料 ①	MSC 82/24/Add.2
<p>ANNEX 24</p> <p>RESOLUTION MSC.232(82)</p> <p>(adopted on 5 December 2006)</p> <p>ADOPTION OF THE REVISED PERFORMANCE STANDARDS FOR ELECTRONIC CHART DISPLAY AND INFORMATION SYSTEMS (ECDIS)</p>	
<p>THE MARITIME SAFETY COMMITTEE,</p> <p>RECALLING Article 28(b) of the Convention on the International Maritime Organization concerning the functions of the Committee,</p> <p>RECALLING ALSO resolution A.886(21), by which the Assembly resolved that the function of adopting performance standards and technical specifications, as well as amendments thereto shall be performed by the Maritime Safety Committee and/or the Marine Environment Protection Committee, as appropriate, on behalf of the Organization,</p> <p>RECALLING ALSO regulations V/19 and V/27 of the International Convention for the Safety of Life at Sea (SOLAS), 1974, which requires all ships to carry adequate and up-to-date charts, sailing directions, lists of lights, notices to mariners, tide tables and all other nautical publications necessary for the intended voyage,</p> <p>NOTING that the up-to-date charts required by SOLAS regulations V/19 and V/27 can be provided and displayed electronically on board ships by electronic chart display and information systems (ECDIS), and that the other nautical publications required by regulation V/27 may also be so provided and displayed,</p> <p>RECOGNIZING the need to improve the previously adopted, by resolution A.817(19), as amended, performance standards for ECDIS in order to ensure the operational reliability of such equipment and taking into account the technological progress and experience gained,</p> <p>HAVING CONSIDERED the recommendation made by the Sub-Committee on Safety of Navigation, at its fifty-second session,</p> <ol style="list-style-type: none"> 1. ADOPTS the Revised performance standards for electronic chart display and information systems (ECDIS), set out in the Annex to the present resolution; 2. RECOMMENDS Governments ensure that ECDIS equipment: <ol style="list-style-type: none"> (a) if installed on or after 1 January 2009, conform to performance standards not inferior to those specified in the Annex to the present resolution; and (b) if installed on or after 1 January 1996 but before 1 January 2009, conform to performance standards not inferior to those specified in the Annex to resolution A.817(19), as amended by resolutions MSC.64(67) and MSC.86(70). 	
I:\MSC\82\24-Add-2.doc	

MSC 82/24/Add.2 ANNEX 24 Page 2	<p>ANNEX</p> <p>REVISED PERFORMANCE STANDARDS FOR ELECTRONIC CHART DISPLAY AND INFORMATION SYSTEMS (ECDIS)</p>
<p>1 SCOPE OF ECDIS</p> <ol style="list-style-type: none"> 1.1 The primary function of the ECDIS is to contribute to safe navigation. 1.2 ECDIS with adequate back-up arrangements may be accepted as complying with the up-to-date charts required by regulations V/19 and V/27 of the 1974 SOLAS Convention, as amended. 1.3 ECDIS should be capable of displaying all chart information necessary for safe and efficient navigation originated by, and distributed on the authority of, government authorized hydrographic offices. 1.4 ECDIS should facilitate simple and reliable updating of the electronic navigational chart. 1.5 ECDIS should reduce the navigational workload compared to using the paper chart. It should enable the mariner to execute in a convenient and timely manner all route planning, route monitoring and positioning currently performed on paper charts. It should be capable of continuously plotting the ship's position. 1.6 The ECDIS display may also be used for the display of radar, radar tracked target information, AIS and other appropriate data layers to assist in route monitoring. 1.7 ECDIS should have at least the same reliability and availability of presentation as the paper chart published by government authorized hydrographic offices. 1.8 ECDIS should provide appropriate alarms or indications with respect to the information displayed or malfunction of the equipment (see appendix 5). 1.9 When the relevant chart information is not available in the appropriate form (see section 4), some ECDIS equipment may operate in the Raster Chart Display System (RCDS) mode as defined in appendix 7. RCDS mode of operation should conform to performance standards not inferior to those set out in appendix 7. <p>2 APPLICATION OF THESE STANDARDS</p> <ol style="list-style-type: none"> 2.1 These performance standards should apply to all ECDIS equipment carried on all ships, as follows: <ul style="list-style-type: none"> - dedicated standalone workstation. - a multifunction workstation as part of an INS. 2.2 These performance standards apply to ECDIS mode of operation, ECDIS in RCDS mode of operation as specified in appendix 7 and ECDIS backup arrangements as specified in appendix 6. 	
I:\MSC\82\24-Add-2.doc	

	MSC 82/24/Add.2 ANNEX 24 Page 3
<ol style="list-style-type: none"> 2.3 Requirements for structure and format of the chart data, encryption of chart data as well as the presentation of chart data are within the scope of relevant IHO standards, including those listed in appendix 1. 2.4 In addition to the general requirements set out in resolution A.694(17)¹, the presentation requirements set out in resolution MSC.191(79), ECDIS equipment should meet the requirements of these standards and follow the relevant guidelines on ergonomic principles adopted by the Organization¹. <p>3 DEFINITIONS</p> <p>For the purpose of these performance standards:</p> <ol style="list-style-type: none"> 3.1 <i>Electronic Chart Display and Information System (ECDIS)</i> means a navigation information system which with adequate back-up arrangements can be accepted as complying with the up-to-date chart required by regulations V/19 and V/27 of the 1974 SOLAS Convention, as amended, by displaying selected information from a system electronic navigational chart (SENC) with positional information from navigation sensors to assist the mariner in route planning and route monitoring, and if required display additional navigation-related information. 3.2 <i>Electronic Navigational Chart (ENC)</i> means the database, standardized as to content, structure and format, issued for use with ECDIS by or on the authority of a Government, authorized Hydrographic Office or other relevant government institution, and conform to IHO standards. The ENC contains all the chart information necessary for safe navigation and may contain supplementary information in addition to that contained in the paper chart (e.g. sailing directions) which may be considered necessary for safe navigation. 3.3 <i>System Electronic Navigational Chart (SENC)</i> means a database, in the manufacturer's internal ECDIS format, resulting from the lossless transformation of the entire ENC contents and its updates. It is this database that is accessed by ECDIS for the display generation and other navigational functions, and is equivalent to an up-to-date paper chart. The SENC may also contain information added by the mariner and information from other sources. 3.4 <i>Standard Display</i> is the display mode intended to be used as a minimum during route planning and route monitoring. The chart content is listed in appendix 2. 3.5 <i>Display Base</i> means the chart content as listed in appendix 2 and which cannot be removed from the display. It is not intended to be sufficient for safe navigation. 3.6 Further information on ECDIS definitions may be found in IHO Hydrographic Dictionary Special Publication S-32 (see appendix 1). 	
<p>¹ Refer to Publication IEC 60945.</p> <p>¹ MSC/Circ.982.</p>	
I:\MSC\82\24-Add-2.doc	

MSC 82/24/Add.2 ANNEX 24 Page 4	<p>MODULE A - DATABASE</p> <p>4 PROVISION AND UPDATING OF CHART INFORMATION</p>
<ol style="list-style-type: none"> 4.1 The chart information to be used in ECDIS should be the latest edition, as corrected by official updates, of that issued by or on the authority of a Government, government-authorized Hydrographic Office or other relevant government institution, and conform to IHO standards². 4.2 The contents of the SENC should be adequate and up-to-date for the intended voyage to comply with regulation V/27 of the 1974 SOLAS Convention as amended. 4.3 It should not be possible to alter the contents of the ENC or SENC information transformed from the ENC. 4.4 Updates should be stored separately from the ENC. 4.5 ECDIS should be capable of accepting official updates to the ENC data provided in conformity with IHO standards. These updates should be automatically applied to the SENC. By whatever means updates are received, the implementation procedure should not interfere with the display in use. 4.6 ECDIS should also be capable of accepting updates to the ENC data entered manually with simple means for verification prior to the final acceptance of the data. They should be distinguishable on the display from ENC information and its official updates and not affect display legibility. 4.7 ECDIS should keep and display on demand a record of updates including time of application to the SENC. This record should include updates for each ENC until it is superseded by a new edition. 4.8 ECDIS should allow the mariner to display updates in order to review their contents and to ascertain that they have been included in the SENC. 4.9 ECDIS should be capable of accepting both non-encrypted ENCs and ENCs encrypted in accordance with the IHO Data Protection Scheme³. 	
<p>² IHO Special Publication S-52 and S-57 (see appendix 1).</p> <p>³ IHO Special Publication S-63 (see appendix 1).</p>	
I:\MSC\82\24-Add-2.doc	



MSC 82/24/Add 2
ANNEX 24
Page 5

MODULE B – OPERATIONAL AND FUNCTIONAL REQUIREMENTS

5 DISPLAY OF SENC INFORMATION

- 5.1** ECDIS should be capable of displaying all SENC information. An ECDIS should be capable of accepting and converting an ENC and its updates into a SENC. The ECDIS may also be capable of accepting a SENC resulting from conversion of ENC to SENC ashore, in accordance with IHO TR 3.11⁴. This method of ENC supply is known as SENC delivery.
- 5.2** SENC information available for display during route planning and route monitoring should be subdivided into the following three categories, Display Base, Standard Display and All Other Information (see appendix 2).
- 5.3** ECDIS should present the Standard Display at any time by a single operator action.
- 5.4** When an ECDIS is switched on following a switch off or power failure, it should return to the most recent manually selected settings for display.
- 5.5** It should be easy to add or remove information from the ECDIS display. It should not be possible to remove information contained in the Display Base.
- 5.6** For any operator identified geographical position (e.g. by cursor picking) ECDIS should display on demand the information about the chart objects associated with such a position.
- 5.7** It should be possible to change the display scale by appropriate steps e.g. by means of either chart scale values or ranges in nautical miles.
- 5.8** It should be possible for the mariner to select a safety contour from the depth contours provided by the SENC. ECDIS should emphasize the safety contour over other contours on the display, however:
- 1 if the mariner does not specify a safety contour, this should default to 30m. If the safety contour specified by the mariner or the default 30 m contour is not in the displayed SENC, the safety contour shown should default to the next deeper contour;
 - 2 if the safety contour in use becomes unavailable due to a change in source data, the safety contour should default to the next deeper contour; and
 - 3 in each of the above cases, an indication should be provided.
- 5.9** It should be possible for the mariner to select a safety depth. ECDIS should emphasize soundings equal to or less than the safety depth whenever spot soundings are selected for display.
- 5.10** The ENC and all updates to it should be displayed without any degradation of their information content.

⁴ IHO Miscellaneous Publication M-3.
I:\MSC\82\24-Add-2.doc

MSC 82/24/Add 2
ANNEX 24
Page 6

- 5.11** ECDIS should provide a means to ensure that the ENC and all updates to it have been correctly loaded into the SENC.
- 5.12** The ENC data and updates to it should be clearly distinguishable from other displayed information, including those listed in appendix 3.
- 6 SCALE**
- 6.1** ECDIS should provide an indication if:
- 1 the information is displayed at a larger scale than that contained in the ENC; or
 - 2 own ship's position is covered by an ENC at a larger scale than that provided by the display.
- 7 DISPLAY OF OTHER NAVIGATIONAL INFORMATION**
- 7.1** Radar information and/or AIS information may be transferred from systems compliant with the relevant standards of the Organization. Other navigational information may be added to the ECDIS display. However, it should not degrade the displayed SENC information and it should be clearly distinguishable from the SENC information.
- 7.2** It should be possible to remove the radar information, AIS information and other navigational information by single operator action.
- 7.3** ECDIS and added navigational information should use a common reference system. If this is not the case, an indication should be provided.
- 7.4** Radar
- 7.4.1** Transferred radar information may contain a radar image and/or tracked target information.
- 7.4.2** If the radar image is added to the ECDIS display, the chart and the radar image should match in scale, projection and in orientation.
- 7.4.3** The radar image and the position from the position sensor should both be adjusted automatically for antenna offset from the conning position.
- 8 DISPLAY MODE AND GENERATION OF THE NEIGHBOURING AREA**
- 8.1** It should always be possible to display the SENC information in a "north-up" orientation. Other orientations are permitted. When such orientations are displayed, the orientation should be altered in steps large enough to avoid unstable display of the chart information.
- 8.2** ECDIS should provide for true motion mode. Other modes are permitted.
- 8.3** When true motion mode is in use, reset and generation of the chart display of the neighbouring area should take place automatically at own ship's distance from the edge of the display as determined by the mariner.

I:\MSC\82\24-Add-2.doc

MSC 82/24/Add 2
ANNEX 24
Page 7

- 8.4** It should be possible to manually change the displayed chart area and the position of own ship relative to the edge of the display.
- 8.5** If the area covered by the ECDIS display includes waters for which no ENC at a scale appropriate for navigation is available, the areas representing those waters should carry an indication (see appendix 5) to the mariner to refer to the paper chart or to the RCDS mode of operation (see appendix 7).
- 9 COLOURS AND SYMBOLS**
- 9.1** IHO recommended colours and symbols should be used to represent SENC information⁵.
- 9.2** The colours and symbols other than those mentioned in 9.1 should comply with the applicable requirements contained in the IMO standards for navigational symbols⁵.
- 9.3** SENC information displayed at the scale specified in the ENC should use the specified size of symbols, figures and letters⁵.
- 9.4** ECDIS should allow the mariner to select whether own ship is displayed in true scale or as a symbol.
- 10 DISPLAY REQUIREMENTS**
- 10.1** ECDIS should be capable of displaying information for:
- 1 route planning and supplementary navigation tasks; and
 - 2 route monitoring.
- 10.2** The effective size of the chart presentation for route monitoring should be at least 270 mm x 270 mm.
- 10.3** The display should be capable of meeting colour and resolution recommendations of IHO⁵.
- 10.4** The method of presentation should ensure that the displayed information is clearly visible to more than one observer in the conditions of light normally experienced on the bridge of the ship by day and by night.
- 10.5** If information categories included in the Standard Display (See appendix 2) are removed to customize the display, this should be permanently indicated. Identification of categories which are removed from the Standard Display should be shown on demand.

⁵ Special Publication S-52, Appendix 2 (see appendix 1)
I:\MSC\82\24-Add-2.doc

MSC 82/24/Add 2
ANNEX 24
Page 8

11 ROUTE PLANNING, MONITORING AND VOYAGE RECORDING

- 11.1** It should be possible to carry out route planning and route monitoring in a simple and reliable manner.
- 11.2** The largest scale data available in the SENC for the area given should always be used by the ECDIS for all alarms or indications of crossing the ship's safety contour and of entering a prohibited area, and for alarms and indications according to appendix 5.
- 11.3 Route Planning**
- 11.3.1** It should be possible to carry out route planning including both straight and curved segments.
- 11.3.2** It should be possible to adjust a planned route alphanumerically and graphically including:
- 1 adding waypoints to a route;
 - 2 deleting waypoints from a route; and
 - 3 changing the position of a waypoint.
- 11.3.3** It should be possible to plan one or more alternative routes in addition to the selected route. The selected route should be clearly distinguishable from the other routes.
- 11.3.4** An indication is required if the mariner plans a route across an own ship's safety contour.
- 11.3.5** An indication should be given if the mariner plans a route closer than a user-specified distance from the boundary of a prohibited area or a geographic area for which special conditions exist (see appendix 4). An indication should also be given if the mariner plans a route closer than a user-specified distance from a point object, such as a fixed or floating aid to navigation or isolated danger.
- 11.3.6** It should be possible for the mariner to specify a cross track limit of deviation from the planned route at which an automatic off-track alarm should be activated.
- 11.4 Route monitoring**
- 11.4.1** For route monitoring the selected route and own ship's position should appear whenever the display covers that area.
- 11.4.2** It should be possible to display a sea area that does not have the ship on the display (e.g. for look ahead, route planning), while route monitoring. If this is done on the display used for route monitoring, the automatic route monitoring functions (e.g. updating ship's position, and providing alarms and indications) should be continuous. It should be possible to return to the route monitoring display covering own ship's position immediately by single operator action.
- 11.4.3** ECDIS should give an alarm if, within a specified time set by the mariner, own ship will cross the safety contour.

I:\MSC\82\24-Add-2.doc

- 11.4.4 ECDIS should give an alarm or indication, as selected by the mariner, if, within a specified time set by the mariner, own ship will cross the boundary of a prohibited area or of a geographical area for which special conditions exist (see appendix 4).
- 11.4.5 An alarm should be given when the specified cross track limit for deviation from the planned route is exceeded.
- 11.4.6 An indication should be given to the mariner if, continuing on its present course and speed, over a specified time or distance set by the mariner, own ship will pass closer than a user-specified distance from a danger (e.g. obstruction, wreck, rock) that is shallower than the mariner's safety contour or an aid to navigation.
- 11.4.7 The ship's position should be derived from a continuous positioning system of an accuracy consistent with the requirements of safe navigation. Whenever possible, a second independent positioning source, preferably of a different type, should be provided. In such cases ECDIS should be capable of identifying discrepancies between the two sources.
- 11.4.8 ECDIS should provide an alarm when the input from position, heading or speed sources is lost. ECDIS should also repeat, but only as an indication, any alarm or indication passed to it from position, heading or speed sources.
- 11.4.9 An alarm should be given by ECDIS when the ship reaches a specified time or distance, set by the mariner, in advance of a critical point on the planned route.
- 11.4.10 The positioning system and the SENC should be on the same geodetic datum. ECDIS should give an alarm if this is not the case.
- 11.4.11 It should be possible to display alternative routes in addition to the selected route. The selected route should be clearly distinguishable from the other routes. During the voyage, it should be possible for the mariner to modify the selected sailing route or change to an alternative route.
- 11.4.12 It should be possible to display:
- 1 time-labels along a ship's track manually on demand and automatically at intervals selected between 1 and 120 minutes; and
 - 2 an adequate number of: points, free movable electronic bearing lines, variable and fixed range markers and other symbols required for navigation purposes and specified in appendix 3.
- 11.4.13 It should be possible to enter the geographical co-ordinates of any position and then display that position on demand. Also, it should be possible to select any point (features, symbol or position) on the display and read its geographical co-ordinates on demand.
- 11.4.14 It should be possible to adjust the displayed geographic position of the ship manually. This manual adjustment should be noted alpha-numerically on the screen, maintained until altered by the mariner and automatically recorded.

I:\MSC\82\24-Add-2.doc

- 11.4.15.1 ECDIS should provide the capability to enter and plot manually obtained bearing and distance lines of position (LOP), and calculate the resulting position of own ship. It should be possible to use the resulting position as an origin for dead-reckoning.
- 11.4.15.2 ECDIS should indicate discrepancies between the positions obtained by continuous positioning systems and positions obtained by manual observations.
- 11.5 Voyage recording**
- 11.5.1 ECDIS should store and be able to reproduce certain minimum elements required to reconstruct the navigation and verify the official database used during the previous 12 hours. The following data should be recorded at one minute intervals:
- 1 to ensure a record of own ship's past track: time, position, heading, and speed; and
 - 2 to ensure a record of official data used: ENC source, edition, date, cell and update history.
- 11.5.2 In addition, ECDIS should record the complete track for the entire voyage, with time marks at intervals not exceeding 4 hours.
- 11.5.3 It should not be possible to manipulate or change the recorded information.
- 11.5.4 ECDIS should have a capability to preserve the record of the previous 12 hours and of the voyage track.
- 12 CALCULATIONS AND ACCURACY**
- 12.1 The accuracy of all calculations performed by ECDIS should be independent of the characteristics of the output device and should be consistent with the SENC accuracy.
- 12.2 Bearings and distances drawn on the display or those measured between features already drawn on the display should have accuracy no less than that afforded by the resolution of the display.
- 12.3 The system should be capable of performing and presenting the results of at least the following calculations:
- 1 true distance and azimuth between two geographical positions;
 - 2 geographic position from known position and distance/azimuth; and
 - 3 geodetic calculations such as spheroidal distance, rhumb line, and great circle.

I:\MSC\82\24-Add-2.doc

13 PERFORMANCE TESTS, MALFUNCTIONS ALARMS AND INDICATIONS

- 13.1 ECDIS should be provided with means for either automatically or manually carrying out on-board tests of major functions. In case of a failure, the test should display information to indicate which module is at fault.
- 13.2 ECDIS should provide a suitable alarm or indication of system malfunction.

14 BACK-UP ARRANGEMENTS

Adequate back-up arrangements should be provided to ensure safe navigation in case of an ECDIS failure; see appendix 6.

- 1 Facilities enabling a safe take-over of the ECDIS functions should be provided in order to ensure that an ECDIS failure does not develop into a critical situation.
- 2 A back-up arrangement should provide means of safe navigation for the remaining part of a voyage in the case of an ECDIS failure.

MODULE C – INTERFACING AND INTEGRATION

15 CONNECTIONS WITH OTHER EQUIPMENT⁷

- 15.1 ECDIS should not degrade the performance of any equipment providing sensor inputs. Nor should the connection of optional equipment degrade the performance of ECDIS below this standard.
- 15.2 ECDIS should be connected to the ship's position fixing system, to the gyro compass and to the speed and distance measuring device. For ships not fitted with a gyro compass, ECDIS should be connected to a marine transmitting heading device.
- 15.3 ECDIS may provide a means to supply SENC information to external equipment.

16 POWER SUPPLY

- 16.1 It should be possible to operate ECDIS and all equipment necessary for its normal functioning when supplied by an emergency source of electrical power in accordance with the appropriate requirements of chapter II-1 of the 1974 SOLAS Convention, as amended.
- 16.2 Changing from one source of power supply to another or any interruption of the supply for a period of up to 45 seconds should not require the equipment to be manually re-initialized.

⁷ Publication IEC 61162.

I:\MSC\82\24-Add-2.doc

Appendix 1 REFERENCE DOCUMENTS

The following international organizations have developed technical standards and specifications, as listed below, for use in conjunction with this standard. The latest edition of these documents should be obtained from the organization concerned:

INTERNATIONAL MARITIME ORGANIZATION (IMO)

Address: International Maritime Organization
 4 Albert Embankment
 London SE1 7SR
 United Kingdom

Phone: +44 207 735 76 11
 Fax: +44 207 587 32 10
 E-mail: info@imo.org
 Web: http://www.imo.org

Publications

IMO resolution MSC.191(79) on Performance Standards for the presentation of navigation related information on shipborne navigational displays

IMO resolution A.694(17) on Recommendations on general requirements for shipborne radio equipment forming part of the Global Maritime Distress and Safety System (GMDSS) and for electronic navigational aids

SN.Circ/207 (1999) on Differences between RCDS and ECDIS

IMO SN.Circ.243 (2004) on Guidelines for the Presentation of Navigation-related Symbols, Terms and Abbreviations

IMO MSC/Circ.982 (2000) on Guidelines on ergonomic criteria for bridge equipment and layout

INTERNATIONAL HYDROGRAPHIC ORGANIZATION (IHO)

Address: Directing Committee
 International Hydrographic Bureau
 BP 445
 MC 98011 Monaco Cedex
 Principality of Monaco

Phone: +377 93 10 81 00
 Fax: +377 93 10 81 40
 E-mail: info@ihh.mc
 Web: http://www.ihh.shom.fr

I:\MSC\82\24-Add-2.doc



JAPAN P&I CLUB P&I Loss Prevention Bulletin

MSC 82/24/Add.2
ANNEX 24
Page 13

Publications

Special Publication No. S-52, Specifications for Chart Content and Display Aspects of ECDIS

Special Publication No. S-52 appendix 1, Guidance on Updating the Electronic Navigational Chart

Special Publication No. S-52 appendix 2, Colour and Symbol Specifications for ECDIS

Special Publication No. S-32, Hydrographic Dictionary

Special Publication No. S-57, IHO Transfer Standard for Digital Hydrographic Data

Special Publication No. S-61, IHO Product specification for Raster Navigational Charts (RNC)

Special Publication No. S-63, IHO Data Protection Scheme

Miscellaneous Publication No. M-3, *Resolutions of the IHO*

INTERNATIONAL ELECTROTECHNICAL COMMISSION (IEC)

Address: IEC Central Office
3 rue de Varembe
PO Box 131
CH-1211 Geneva 20
Switzerland

Phone: +41 22 734 01 50
Fax: +41 22 733 38 43

Publications

IEC Publication 61174, Electronic Chart Display and Information Systems (ECDIS) - Operational and Performance Requirements, Method of Testing and Required Test Results.

IEC Publication 60945, General Requirements for Shipborne Radio Equipment Forming Part of the Global Maritime Distress and Safety System and Marine Navigational Equipment.

IEC Publication 61162, *Digital Interfaces - Navigation and Radiocommunication Equipment On board Ship.*

[IEC Publication 62288, Maritime Navigation and Radiocommunication Equipment and Systems - Presentation of navigation related information - General requirements, methods of test and required test results.]

I:\MSC\82\24-Add-2.doc

MSC 82/24/Add.2
ANNEX 24
Page 14

Appendix 2

SENC INFORMATION AVAILABLE FOR DISPLAY DURING ROUTE PLANNING AND ROUTE MONITORING

- 1 Display base to be permanently shown on the ECDIS display, consisting of:
 - .1 coastline (high water);
 - .2 own ship's safety contour;
 - .3 isolated underwater dangers of depths less than the safety contour which lie within the safe waters defined by the safety contour;
 - .4 isolated dangers which lie within the safe water defined by the safety contour, such as fixed structures, overhead wires, etc.;
 - .5 scale, range and north arrow;
 - .6 units of depth and height; and
 - .7 display mode.
- 2 Standard display consisting of:
 - .1 display base
 - .2 drying line
 - .3 buoys, beacons, other aids to navigation and fixed structures
 - .4 boundaries of fairways, channels, etc.
 - .5 visual and radar conspicuous features
 - .6 prohibited and restricted areas
 - .7 chart scale boundaries
 - .8 indication of cautionary notes
 - .9 ships' routing systems and ferry routes
 - .10 archipelagic sea lanes.
- 3 All other information, to be displayed individually on demand, for example:
 - .1 spot soundings
 - .2 submarine cables and pipelines
 - .3 details of all isolated dangers
 - .4 details of aids to navigation
 - .5 contents of cautionary notes
 - .6 ENC edition date
 - .7 most recent chart update number
 - .8 magnetic variation
 - .9 graticule
 - .10 place names.

I:\MSC\82\24-Add-2.doc

MSC 82/24/Add.2
ANNEX 24
Page 15

Appendix 3

NAVIGATIONAL ELEMENTS AND PARAMETERS

- 1 Own ship.
 - .1 Past track with time marks for primary track.
 - .2 Past track with time marks for secondary track.
- 2 Vector for course and speed made good.
- 3 Variable range marker and/or electronic bearing line.
- 4 Cursor.
- 5 Event.
 - .1 Dead reckoning position and time (DR).
 - .2 Estimated position and time (EP).
- 6 Fix and time.
- 7 Position line and time.
- 8 Transferred position line and time.
 - .1 Predicted tidal stream or current vector with effective time and strength.
 - .2 Measured tidal stream or current vector with effective time and strength.
- 9 Danger highlight.
- 10 Clearing line.
- 11 Planned course and speed to make good.
- 12 Waypoint.
- 13 Distance to run.
- 14 Planned position with date and time.
- 15 Visual limits of lights arc to show rising/dipping range.
- 16 Position and time of "wheel over".

I:\MSC\82\24-Add-2.doc

MSC 82/24/Add.2
ANNEX 24
Page 16

Appendix 4

AREAS FOR WHICH SPECIAL CONDITIONS EXIST

The following are the areas which ECDIS should detect and provide an alarm or indication under sections 11.3.5 and 11.4.4:

Traffic separation zone
Inshore traffic zone
Restricted area
Caution area
Offshore production area
Areas to be avoided
User defined areas to be avoided
Military practise area
Seaplane landing area
Submarine transit lane
Anchorage area
Marine farms/aquaculture
PSSA (Particularly Sensitive Sea Area)

I:\MSC\82\24-Add-2.doc

Appendix 5
ALARMS AND INDICATORS

Section	Requirements	Information
11.4.3	Alarm	Crossing safety contour
11.4.4	Alarm or Indication	Area with special conditions
11.4.5	Alarm	Deviation from route
11.4.8	Alarm	Positioning system failure
11.4.9	Alarm	Approach to critical point
11.4.10	Alarm	Different geodetic datum
13.2	Alarm or Indication	Malfunction of ECDIS
5.8.3	Indication	Default safety contour
6.1.1	Indication	Information overscale
6.1.2	Indication	Larger scale ENC available
7.3	Indication	Different reference system
8.5	Indication	No ENC available
10.5	Indication	Customized display
11.3.4	Indication	Route planning across safety contour
11.3.5	Indication	Route planning across specified area
11.4.6	Indication	Crossing a danger in route monitoring mode
13.1	Indication	System test failure

In this Performance Standard the definitions of Indicators and Alarms provided in the IMO resolution A.830(19) "Code on Alarms and Indicators, 1995" apply.

Alarm: An alarm or alarm system which announces by audible means, or audible and visual means, a condition requiring attention.

Indicator: Visual indication giving information about the condition of a system or equipment.

I:\MSC\82\24-Add-2.doc

Appendix 6
BACK-UP REQUIREMENTS

1 INTRODUCTION

As prescribed in section 14 of this performance standard, adequate independent back-up arrangements should be provided to ensure safe navigation in case of ECDIS failure. Such arrangements include:

- .1 facilities enabling a safe take-over of the ECDIS functions in order to ensure that an ECDIS failure does not result in a critical situation;
- .2 a means to provide for safe navigation for the remaining part of the voyage in case of ECDIS failure.

2 PURPOSE

The purpose of an ECDIS back-up system is to ensure that safe navigation is not compromised in the event of ECDIS failure. This should include a timely transfer to the back-up system during critical navigation situations. The back-up system shall allow the vessel to be navigated safely until the termination of the voyage.

3 FUNCTIONAL REQUIREMENTS
3.1 Required functions and their availability
3.1.1 Presentation of chart information

The back-up system should display in graphical (chart) form the relevant information of the hydrographic and geographic environment which are necessary for safe navigation.

3.1.2 Route planning

The back-up system should be capable of performing the route planning functions, including:

- .1 taking over of the route plan originally performed on the ECDIS;
- .2 adjusting a planned route manually or by transfer from a route planning device.

3.1.3 Route monitoring

The back-up system should enable a take-over of the route monitoring originally performed by the ECDIS, and provide at least the following functions:

- .1 plotting own ship's position automatically, or manually on a chart;
- .2 taking courses, distances and bearings from the chart;
- .3 displaying the planned route;

I:\MSC\82\24-Add-2.doc

- .4 displaying time labels along ship's track;
- .5 plotting an adequate number of points, bearing lines, range markers, etc., on the chart.

3.1.4 Display information

If the back-up is an electronic device, it should be capable of displaying at least the information equivalent to the standard display as defined in this performance standard.

3.1.5 Provision of chart information

- .1 The chart information to be used in the backup arrangement should be the latest edition, as corrected by official updates, of that issued by or on the authority of a Government, authorized Hydrographic Office or other relevant government institution, and conform to IHO standards.
- .2 It should not be possible to alter the contents of the electronic chart information.
- .3 The chart or chart data edition and issuing date should be indicated.

3.1.6 Updating

The information displayed by the ECDIS back-up arrangements should be up-to-date for the entire voyage.

3.1.7 Scale

If an electronic device is used, it should provide an indication:

- .1 if the information is displayed at a larger scale than that contained in the database; and
- .2 if own ship's position is covered by a chart at a larger scale than that provided by the system.

3.1.8 If radar and other navigational information are added to an electronic back-up display, all the corresponding requirements for radar information and other navigation information of this performance standard should be met.

3.1.9 If an electronic device is used, the display mode and generation of the neighbouring area should be in accordance with section 8 of this performance standard.

3.1.10 Voyage recording

The back-up arrangements should be able to keep a record of the ship's actual track, including positions and corresponding times.

I:\MSC\82\24-Add-2.doc

3.2 Reliability and accuracy
3.2.1 Reliability

The back-up arrangements should provide reliable operation under prevailing environmental and normal operating conditions.

3.2.2 Accuracy

Accuracy should be in accordance with section 12 of this performance standard.

3.3 Malfunctions, warnings, alarms and indications

If an electronic device is used, it should provide a suitable alarm or indication of system malfunction.

4 OPERATIONAL REQUIREMENTS
4.1 Ergonomics

If an electronic device is used, it should be designed in accordance with the ergonomic principles of ECDIS.

4.2 Presentation of information

If an electronic device is used:

- .1 Colours and symbols should be in accordance with the colours and symbols requirements of ECDIS.
- .2 The effective size of the chart presentation should be not less than 250 mm x 250 mm or 250 mm diameter.

5 POWER SUPPLY

If an electronic device is used:

- .1 the back-up power supply should be separate from the ECDIS; and
- .2 conform to the requirements in this ECDIS performance standard.

6 CONNECTIONS WITH OTHER EQUIPMENT

6.1 If an electronic device is used, it should:

- .1 be connected to systems providing continuous position-fixing capability; and
- .2 not degrade the performance of any equipment providing sensor input.

6.2 If radar with selected parts of the ENC chart information overlay is used as an element of the back-up, the radar should comply with resolution MSC.192(79).

I:\MSC\82\24-Add-2.doc



JAPAN P&I CLUB P&I Loss Prevention Bulletin

MSC 82/24/Add.2
ANNEX 24
Page 21

Appendix 7 RCDS MODE OF OPERATION

Whenever in this appendix reference is made to any provisions of the annex related to ECDIS, the term ECDIS should be substituted by the term RCDS, SENC by SRNC and ENC by RNC, as appropriate.

This appendix refers to each paragraph of the performance standards for ECDIS (i.e. the Annex to which this part is appendix 7) and specifies which paragraphs of the Annex either:

- .1 apply to RCDS; or
- .2 do not apply to RCDS; or
- .3 are modified or replaced as shown in order to apply to RCDS.

Any additional requirements applicable to RCDS are also described.

1 SCOPE

- 1.1 Paragraph applies to RCDS.
- 1.2 When operating in RCDS-mode, an appropriate portfolio of up-to-date paper charts (APC) should be carried on board and be readily available to the mariner.
- 1.3 - 1.7 Paragraphs apply to RCDS.
- 1.8 RCDS should provide appropriate alarms or indications with respect to the information displayed or malfunction of the equipment (see Table 1 of this appendix).
- 1.9 Refers to Appendix 7 and applies to RCDS.

2 APPLICATION OF THESE STANDARDS

- 2.1 - 2.4 Paragraphs apply to RCDS.

3 DEFINITIONS

- 3.1 *Raster Chart Display System* (RCDS) means a navigation information system displaying RNCs with positional information from navigation sensors to assist the mariner in route planning and route monitoring, and if required, display additional navigation-related information.
- 3.2 *Raster Navigational Chart* (RNC) means a facsimile of a paper chart originated by, or distributed on the authority of, a government-authorized hydrographic office. RNC is used in these standards to mean either a single chart or a collection of charts.

I:\MSC\82\24-Add-2.doc

MSC 82/24/Add.2
ANNEX 24
Page 22

- 3.3 *System Raster Navigational Chart Database* (SRNC) means a database resulting from the transformation of the RNC by the RCDS to include updates to the RNC by appropriate means.

- 3.4-3.5 Paragraphs do not apply to RCDS.

- 3.6 Paragraph applies to RCDS.

- 3.7 *Appropriate Portfolio of up to date paper Charts* (APC) means a suite of paper charts of a scale to show sufficient detail of topography, depths, navigational hazards, aids to navigation, charted routes, and routing measures to provide the mariner with information on the overall navigational environment. The APC should provide adequate look-ahead capability. Coastal States will provide details of the charts which meet the requirement of this portfolio, and these details are included in a worldwide database maintained by the IHO. Consideration should be given to the details contained in this database when determining the content of the APC.

MODULE A - DATABASE

4 PROVISION AND UPDATING OF CHART INFORMATION

- 4.1 The RNC used in RCDS should be the latest edition of that originated by, or distributed on the authority of, a government authorized hydrographic office and conform to IHO standards. RNCs not on WGS 84 or PE-90 should carry meta-data (i.e., additional data) to allow geo-referenced positional data to be displayed in the correct relationship to SRNC data.

- 4.2 The contents of the SRNC should be adequate and up-to-date for that part of the intended voyage not covered by ENC.

- 4.3 It should not be possible to alter the contents of the RNC.

- 4.4 - 4.8 All paragraphs apply to RCDS.

- 4.9 Paragraph does not apply to RCDS

MODULE B - OPERATIONAL AND FUNCTIONAL REQUIREMENTS

5 DISPLAY OF SRNC INFORMATION

- 5.1 RCDS should be capable of displaying all SRNC information.

- 5.2 SRNC information available for display during route planning and route monitoring should be subdivided into two categories:

- .1 the RCDS standard display consisting of RNC and its updates, including its scale, the scale at which it is displayed, its horizontal datum, and its units of depths and heights; and
- .2 any other information such as mariner's notes.

I:\MSC\82\24-Add-2.doc

MSC 82/24/Add.2
ANNEX 24
Page 23

- 5.3- 5.4 Paragraphs apply to RCDS.

- 5.5 It should be easy to add to, or remove from; the RCDS display any information additional to the RNC data, such as mariner's notes. It should not be possible to remove any information from the RNC.

- 5.6 - 5.9 Paragraphs do not apply to RCDS.

- 5.10 - 5.12 Paragraphs apply to RCDS.

- 5.13 There should always be an indication if the ECDIS equipment is operating in RCDS mode.

6 SCALE

This section applies to RCDS.

7 DISPLAY OF OTHER NAVIGATIONAL INFORMATION

- 7.1 - 7.4 All paragraphs apply to RCDS.

8 DISPLAY MODE AND GENERATION OF THE NEIGHBOURING AREA

- 8.1 It should always be possible to display the SRNC in "chart-up" orientation. Other orientations are permitted.

- 8.2 - 8.4 All paragraphs apply to RCDS.

- 8.5 Paragraph refers to RCDS mode of operation.

9 COLOURS AND SYMBOLS

- 9.1 IHO recommended colours and symbols should be used to represent SRNC information.

- 9.2 Paragraph applies to RCDS.

- 9.3 Paragraph does not apply to RCDS.

- 9.4 Paragraph applies to RCDS.

10 DISPLAY REQUIREMENTS

- 10.1-10.2 Paragraphs apply to RCDS.

- 10.3 Paragraph does not apply to RCDS.

I:\MSC\82\24-Add-2.doc

MSC 82/24/Add.2
ANNEX 24
Page 24

- 10.4 Paragraph applies to RCDS.

- 10.5 Paragraph does not apply to RCDS.

- 10.6 RCDS should be capable of displaying, simply and quickly, chart notes which are not located on the portion of the chart currently being displayed.

11 ROUTE PLANNING, MONITORING AND VOYAGE RECORDING

- 11.1 Paragraphs apply to RCDS.

- 11.2 Paragraph does not apply to RCDS.

11.3 Route Planning

- 11.3.1-11.3.3 Paragraphs apply to RCDS.

- 11.3.4-11.3.5 Paragraphs do not apply to RCDS.

- 11.3.6 Paragraph applies to RCDS.

- 11.3.7 It should be possible for the mariner to enter points, lines and areas which activate an automatic alarm. The display of these features should not degrade the SRNC information and it should be clearly distinguishable from the SRNC information.

11.4 Route monitoring

- 11.4.1 Paragraph applies to RCDS.

- 11.4.2 It should be possible to display a sea area that does not have the ship on the display (e.g. for look ahead, route planning), while route monitoring. If this is done on the display used for route monitoring, the automatic route monitoring functions in 10.4.6 and 10.4.7 should be continuous. It should be possible to return to the route monitoring display covering own ship's position immediately by single operator action.

- 11.4.3-11.4.4 Paragraphs do not apply to RCDS.

- 11.4.5 Paragraph apply to RCDS.

- 11.4.6 Paragraphs do not apply to RCDS.

- 11.4.7-11.4.9 Paragraphs apply to RCDS.

- 11.4.10 The RCDS should only accept positional data referenced to the WGS 84 or PE-90 geodetic datum. RCDS should give an alarm if the positional data is not referenced to one of these datum. If the displayed RNC cannot be referenced to the WGS 84 or PE-90 datum then a continuous indication should be provided.

I:\MSC\82\24-Add-2.doc

- 11.4.11-11.4.15 Paragraphs apply to RCDS.
- 11.4.16 RCDS should allow the user to manually align the SRNC with positional data. This can be necessary, for example, to compensate for local charting errors.
- 11.4.17 It should be possible to activate an automatic alarm when the ship crosses a point, line, or is within the boundary of a mariner entered feature within a specified time or distance.
- 11.5 **Voyage recording**
- 11.5.1-11.5.4 All paragraphs apply to RCDS.
- 12 **CALCULATIONS AND ACCURACY**
- 12.1-12.3 All paragraphs apply to RCDS.
- 12.4 RCDS should be capable of performing transformations between a local datum and WGS 84 Datum.
- 13 **PERFORMANCE TESTS, MALFUNCTION ALARMS AND INDICATIONS**
- 13.1-13.2 All paragraphs apply to RCDS.
- 14 **BACK-UP ARRANGEMENTS**
- All paragraphs apply to RCDS.
- MODULE C – INTERFACING AND INTEGRATION**
- 15 **CONNECTIONS WITH OTHER EQUIPMENT**
- 15.1-15.3 All paragraphs apply to RCDS.
- 16 **POWER SUPPLY**
- 16.1-16.2 All paragraphs apply to RCDS.

Table 1
ALARMS AND INDICATORS IN THE RCDS MODE OF OPERATION

Paragraph	Requirement	Information
11.4.5	Alarm	Deviation from route
11.4.17	Alarm	Approach to mariner entered feature, e.g. area, line
11.4.8	Alarm	Position system failure
11.4.9	Alarm	Approach to critical point
11.4.10	Alarm or indication	Different geodetic datum
13.2	Alarm or indication	Malfunction of RCDS mode
5.13	Indication	ECDIS operating in the raster mode
6.1	Indication	Larger scale information available, or overscale
6.1.2	Indication	Larger scale RNC available for the area of the vessel

Note: The definitions of alarms and indicators are given in appendix 5.



Attachments ②

Ref. T2-OSSHE/2.7.1 SN.1/Circ.255 (24 July 2006) "ADDITIONAL GUIDANCE ON CHART DATUMS AND THE ACCURACY OF POSITIONS ON CHARTS": IMO Safety of Navigation circular: Guidance on chart datum's and accuracy of positions on charts

添付資料 ②

INTERNATIONAL MARITIME ORGANIZATION
4 ALBERT EMBANKMENT
LONDON SE1 7SR

Telephone: 020 7587 3152
Fax: 020 7587 3210



IMO

E

Ref. T2-OSSHE/2.7.1

SN.1/Circ.255
24 July 2006

**ADDITIONAL GUIDANCE ON CHART DATUMS AND THE ACCURACY
OF POSITIONS ON CHARTS**

1 The Sub-Committee on Safety of Navigation, at its fifty-second session (17 to 21 July 2006), approved additional guidance on chart datums and the accuracy of positions on charts, given at annex. This guidance is provided in addition to the guidance contained in SN/Circ.213 dated 31 May 2000.

2 Member Governments are invited to bring this guidance to the attention of all concerned for information, in particular, by having them published in pertinent official nautical publications and action, as appropriate.

SN.1/Circ.255

ANNEX**ADDITIONAL GUIDANCE ON CHART DATUMS AND THE ACCURACY
OF POSITIONS ON CHARTS**

In some areas of the world there are charts that are based on old surveys for which there is no determined geodetic datum or the datum is imprecise. Therefore in such areas, paper charts (and thus raster navigational charts) are not compatible with GNSS navigation, and it will take some time to resolve this problem. This makes it extremely difficult to accurately plot the ship's position obtained by the GNSS in relation to surrounding dangers on such charts. The difference in the plotted position can often be significant and could lead to a casualty or unnecessary risk in restricted waters.

Cross-checking of position using visual or radar fixing or ECDIS radar overlay can provide for the immediate detection of datum inconsistencies in electronic charts, and immediately alert the mariner on potential positional shifts required for particular charts. Some ECDIS equipment exceeds the minimum requirements of the ECDIS Performance standards, by providing such features as radar overlay.

In general, when navigating with GNSS, mariners should undertake all available measures to check the position of the ship obtained by continuous position fixing systems and plotted on any charts, such as using radar and visual observation methods.



Attachments ③

Ref. T2-OSS/2.7 SN.1/Circ.207/Rev.1 (22 October 2007) "DIFFERENCES BETWEEN RCDS AND ECDIS": IMO Safety of Navigation circular: Differences between the Raster Chart Display System (RCDS) and Electronic Chart Display and Information System (ECDIS)

添付資料 ③

INTERNATIONAL MARITIME ORGANIZATION
4 ALBERT EMBANKMENT
LONDON SE1 7SR

Telephone: 020 7735 7611
Fax: 020 7587 3210



E

Ref. T2-OSS/2.7

SN.1/Circ.207/Rev.1
22 October 2007

DIFFERENCES BETWEEN RCDS AND ECDIS

1 The Maritime Safety Committee, at its eighty-third session (3 to 12 October 2007), adopted revised performance standards for Electronic Chart Display and Information Systems (ECDIS) and accordingly agreed to the revision of SN/Circ.207 on difference between Raster Chart Display System (RCDS) and ECDIS.

2 ECDIS has the ability to operate in two modes:

- .1 the ECDIS mode when Electronic Navigational Charts (ENCs) are used; and
- .2 the RCDS mode when ENCs are not available and Raster Navigational Charts (RNCs) are used instead.

However, the RCDS mode does not have the full functionality of ECDIS, and can only be used together with an appropriate portfolio of up-to-date paper charts.

3 The mariners' attention is therefore drawn to the following limitations of the RCDS mode:

- .1 unlike ENC, where there are no displayed boundaries, RNCs are based on paper charts and as such have boundaries which are evident in ECDIS;
- .2 RNCs will not trigger automatic alarms (e.g., anti-grounding). However alarms and indications can be generated with the manual addition, during passage planning, e.g., of clearing lines, ship safety contour lines, isolated danger markers and danger areas to mitigate these limitations;
- .3 horizontal datums and chart projections may differ between RNCs. Mariners should understand how a chart's horizontal datum relates to the datum of the position fixing system in use. In some instances, this may appear as a shift in position. This difference may be most noticeable at grid intersections;
- .4 a number of RNCs cannot be referenced to either WGS-84 or PE 90 geodetic datums. Where this is the case, ECDIS should give a continuous indication;
- .5 the display of RNCs features cannot be simplified by the removal of features to suit a particular navigational circumstance or task at hand. This could affect the superimposition of radar/ARPA;
- .6 without selecting different scale charts the look-ahead capability may be limited. This may lead to inconvenience when determining range and bearing or the identity of distant objects;

I:\CIRC\SN\01\207-Rev-1.doc

SN.1/Circ.207/Rev.1

- 2 -

- .7 orientation of the RCDS display to other than chart-up, may affect the readability of chart text and symbols (e.g., course-up, route-up);
- .8 it is not possible to interrogate RNC features to gain additional information about charted objects. Whether using ENC or RNC, in the planning process a navigator should consult all relevant publications (such as sailing directions, etc.);
- .9 with RNC it is not possible to display a ship's safety contour or safety depth and highlight it on the display, unless these features are manually entered during route planning;
- .10 depending on the source of the RNC, different colours may be used to show similar chart information. There may also be differences in colours used during day and night time;
- .11 an RNC is intended to be used at the scale of the equivalent paper chart. Excessive zooming in or zooming out can seriously degrade the displayed image. If the RNC is displayed at a larger scale than the equivalent paper chart, the ECDIS will provide an indication; and
- .12 ECDIS provides an indication in the ENC which allows a determination of the quality of hydrographic the data. When using RNCs, mariners are invited to consult the source diagram or the zone of confidence diagram, if available.

4 Member Governments are requested to bring this information to the attention of the relevant authorities and all seafarers for guidance and action, as appropriate.



Attachments ④

Ref. T2-OSS/2.7.1 SN.1/Circ.276(10 December 2008) "TRANSITIONING FROM PAPER CHART TO ELECTRONIC CHART DISPLAY AND INFORMATION SYSTEMS (ECDIS) NAVIGATION": Guidance on switching from "navigation using paper charts" to "navigation using ECDIS"

添付資料 ④

INTERNATIONAL MARITIME ORGANIZATION
4 ALBERT EMBANKMENT
LONDON SE1 7SR

Telephone: 020 7735 7611
Fax: 020 7587 3210



IMO

E

Ref. T2-OSS/2.7.1

SN.1/Circ.276
10 December 2008

**TRANSITIONING FROM PAPER CHART TO ELECTRONIC CHART DISPLAY
AND INFORMATION SYSTEMS (ECDIS) NAVIGATION**

1 The Sub-Committee on Safety of Navigation (NAV), at its fifty-fourth session (30 June to 4 July 2008), while developing draft carriage requirements for ECDIS, recognizing that proper training will be an important factor in the successful implementation of an ECDIS carriage requirement; and, notwithstanding the expectation that the current review of the STCW Convention and STCW Code, due for completion in 2010, will fully take into account the human element and training requirements necessary for a smooth transition from the use of paper charts to ECDIS, agreed that Administrations, seafarers, shipowners and operators, maritime training organizations and ECDIS equipment manufacturers would all benefit from corresponding guidance transitioning from paper chart to ECDIS navigation, whenever ships are first equipped with ECDIS, regardless of whether or not it is part of a mandatory carriage requirement.

2 The NAV Sub-Committee therefore developed Guidance on transitioning from paper chart to Electronic Chart Display and Information Systems (ECDIS) navigation, as set out in the annex.

3 The Maritime Safety Committee, at its eighty-fifth session (26 November to 5 December 2008), concurred with the Sub-Committee's views, approved the Guidance on transitioning from paper chart to Electronic Chart Display and Information Systems (ECDIS) navigation, as set out in the annex and encouraged their use by the relevant authorities.

4 Contracting Governments and international organizations are invited to bring the annexed Guidance to the attention of all concerned.

ANNEX**GUIDANCE ON TRANSITIONING FROM PAPER CHART TO ECDIS NAVIGATION****Introduction**

1 The following guidance and information is provided to assist those involved with the transition from paper chart to ECDIS navigation.

Transition and training

2 As an initial step, shipowners and operators should undertake an assessment of the issues involved in changing from paper chart to ECDIS navigation. Ships' crews should participate in any such assessment so as to capture any practical concerns or needs of those that would be required to use ECDIS. Such a process will help facilitate an early understanding of any issues to be addressed and will aid ships' crews prepare for change.

3 Documenting the assessment of issues, combined with the development of ECDIS standard operating procedures, will help lead to the adoption of robust ECDIS navigation practices, simplification of crew training and facilitate smooth handovers between crews.

4 In addition, shipowners and operators should ensure that their ships' crews are provided with a comprehensive familiarization programme* and type-specific training; and that the ships' crew fully understand that the use of electronic charts aboard ship continues to require the need for passage planning.

IHO catalogue of chart coverage

5 The International Hydrographic Organization (IHO) provides an online chart catalogue that details the coverage of Electronic Navigational Charts (ENC) and Raster Navigational Charts (RNC) (where they exist and where there is not yet ENC coverage) together with references to coastal State guidance on any requirements for paper charts (where this has been provided). The catalogue also provides links to IHO Member States' websites where additional information may be found. The IHO online chart catalogue can be accessed from the IHO website at: www.iho.int.

Additional information

6 In addition to national and international rules, regulations, the IMO model course and performance standards, the IHO has published an online publication *Facts about electronic charts and carriage requirements*. It is a recommended source of information on ECDIS hardware, training and the technical aspects of electronic chart data. Copies are available free of charge from various sources including: www.iho.int and http://www.ic-enc.org/page_news_articles2.asp?id=12.

* IMO Model Course 1.27 on Operational Use of Electronic Chart Display and Information Systems (ECDIS).



SN.1/Circ.276

ANNEX

Page 2

7 Another useful source of information on ECDIS is *The Electronic Chart*, 2nd edition, by Hecht, Berking, Büttgenbach, Jonas and Alexander (2006). This book describes the basic components, functionality and capabilities and limitations of ECDIS. *The Electronic Chart* is published by GITC, The Netherlands, ISBN: 90-806205-7-2 and is available via: www.hydro-international.com.

8 Reference should also be made to other Safety of Navigation Circulars (SN/Circs.) issued by the Organization, in particular, SN/Circ.207/Rev.1 on Differences between RCDS and ECDIS; SN/Circ.213 on Guidance on chart datums and the accuracy of positions on charts; SN/Circ.255 on Additional guidance on chart datums and the accuracy of positions on charts; and SN/Circ.266 on Maintenance of Electronic Chart Display and Information System (ECDIS) software. These and other IMO guidance material can be downloaded from the IMO website, www.imo.org.

9 Shipowners and operators should always refer to their national Administrations for the latest information on ECDIS carriage and use.

Attachments ⑤

STCW Convention Table A-II/2 Extract

Table A-II/2

Specification of minimum standard of competence for masters and chief mates on ships of 500 gross tonnage or more

Function : Navigation at the management level

Attached ⑤ -1 STCW

Column 1	Column 2	Column 3	Column 4
COMPETENCE	KNOWLEDGE, UNDERSTANDING AND PROFICIENCY	METHODS FOR DEMONSTRATING COMPETENCE	CRITERIA FOR EVALUATING COMPETENCE
Plan a Voyage and conduct navigation	Voyage planning and navigation for all conditions by acceptable methods of plotting ocean tracks taking into account, e.g. : .1 restricted waters .2 meteorological conditions .3 ice .4 restricted visibility .5 traffic separation schemes .6 vessel traffic service(VTS) area .7 areas of extensive tidal effect Routing in accordance with the General Provisions on Ship's Routing Reporting in accordance with the General principles for Ship Reporting Systems and with VTS procedures	Examination and assessment of evidence obtained from one or more of the following : .1 approved in-service experience .2 approved simulator training, where appropriate .3 approved laboratory equipment, training using : chart catalogues, charts, nautical publications and ship particulars.	The equipment, charts and nautical publications required for the voyage are enumerated and appropriate to the safe conduct of the voyage The reasons for the planned route are supported by facts and statistical data obtained from relevant sources and publications. Positions, courses, distances and time calculations are correct within accepted accuracy standards for navigational equipment. All potential navigational hazards are accurately identified.

Table A-II/2 Page 1 of 19 pages

Attached ⑤ -2 STCW

COMPETENCE	KNOWLEDGE, UNDERSTANDING AND PROFICIENCY	METHODS FOR DEMONSTRATING COMPETENCE	CRITERIA FOR EVALUATING COMPETENCE
Maintain safe navigation through the use of ECDIS and associated navigation systems to assist command decision making Note : Training and assessment in the use of ECDIS is not required for those who serve exclusively on ship not fitted with ECDIS. This limitation shall be reflected in the endorsement issued to the seafarer conducted.	Management of operational procedures, systems files and data, including ; .1 manage procurement, licensing and updating of chart data and system software to conform to established procedures. .2 system and information updating, including the ability to update ECDIS system version in accordance with vendor's product development. .3 create and maintain system configuration and backup files. .4 create and maintain log files in accordance with established procedures. .5 create and maintain route plan files in accordance with established procedure .6 use ECDIS log-book and track history functions for inspection of system functions, alarm setting and user responses Use ECDIS playback functionality for passage review, route planning and review of system functions	Assessment of evidence obtained from one of the following; .1 approved in-service experience .2 approved training ship experience .3 approved ECDIS simulator training	Operational procedures for using ECDIS are established, applied, and monitored Action taken to minimize risk to safety of navigation

Table A-II/2 Page 6 and 7 of 19 pages



JAPAN P&I CLUB

P&I Loss Prevention Bulletin



A photograph of the author
(Master Mariner, Capt. Takuzo Okada)



株式会社 日本海洋科学
Japan Marine Science Inc.

Largest Total Marine Consultant in Japan

Jointly written by:

- Master Mariner Capt. Takuzo Okada, Loss Prevention and Ship Inspection Department, Japan P&I Club
 - Japan Marine Science Inc.
-